

Temperature Compensated Crystal Oscillator (TCXO)

- Package size (2.0 mm × 1.6 mm × 0.73 mm)
- High stability TCXO
- Output waveform : Clipped sine wave

[1] Product Number / Product Name

(1-1) Product Number / Ordering Code

X1G0054410321xx

last 2 digits code(xx) define Quantity.

The standard is "25", 12 000 pcs/Reel.

(1-2) Product Name / Model Name

TG2016SMN 27.60000 MHz MCGNNM

[2] Operating Conditions

| Parameter | Symbol | Specifications | | | Unit | Conditions |
|-----------------------------|--------|----------------|------|-------|------|--------------------|
| | | Min. | Typ. | Max. | | |
| Supply voltage | Vcc | 2.66 | - | 3.465 | V | - |
| | GND | 0 | - | 0 | V | - |
| Operating temperature range | T_use | -40 | - | +85 | °C | - |
| Output load | Load_R | 9 | 10 | 11 | kΩ | - |
| | Load_C | 9 | 10 | 11 | pF | - |
| | Cc | 0.01 | - | - | μF | DC-cut capacitor * |

* DC-cut capacitor is not included in this TCXO. Please attach an external DC-cut capacitor to the out pin.

[3] Frequency Characteristics

(Vcc = 2.66 to 3.465 V, GND = 0.0 V, Load = 10 kΩ // 10 pF, T_use = +25 °C)

| Parameter | Symbol | Specifications | | | Unit | Conditions |
|---|---------|----------------|------|------|-------------------|---|
| | | Min. | Typ. | Max. | | |
| Output Frequency | fo | - | 27.6 | - | MHz | |
| Frequency tolerance | f_tol | -0.5 | - | +0.5 | x10 ⁻⁶ | T_use = +25 °C ± 2 °C Before reflow |
| Frequency tolerance *1 | f_tol | -1.5 | - | +1.5 | x10 ⁻⁶ | T_use = +25 °C ± 2 °C After 2 reflows *2 |
| Frequency / temperature characteristics | fo-Tc | -0.5 | - | +0.5 | x10 ⁻⁶ | T_use = -40 °C to +85 °C (Reference to +25 °C) |
| Frequency / load coefficient | fo-Load | -0.1 | - | +0.1 | x10 ⁻⁶ | Load ± 10 % |
| Frequency / voltage coefficient | fo-Vcc | -0.1 | - | +0.1 | x10 ⁻⁶ | Vcc ± 5 % *3 |
| Frequency aging *4 | f_age | -0.5 | - | +0.5 | x10 ⁻⁶ | T_use = +25 °C first year |
| | | -3.5 | - | +3.5 | x10 ⁻⁶ | T_use = +25 °C 10 years |

*1 Include initial frequency tolerance and frequency deviation after reflow cycles.

*2 Measured in the elapse of 24 hours after reflow soldering.

*3 Vcc ± 5 % must be in operating supply voltage range (2.66 V to 3.465 V)

*4 Aging stability is estimated from environmental reliability tests; expected amount of the frequency variation.

[4] Electrical Characteristics

(Vcc = 2.66 to 3.465 V, GND = 0.0 V, Load = 10 kΩ // 10 pF, T_use = +25 °C)

| Parameter | Symbol | Specifications | | | Unit | Conditions |
|---------------------|--------|----------------|------|------|------|---|
| | | Min. | Typ. | Max. | | |
| Current consumption | Icc | - | - | 1.8 | mA | - |
| Output level | Vpp | 0.8 | - | - | V | Peak to peak voltage |
| Symmetry | SYM | 45 | 50 | 55 | % | GND level (DC-cut) |
| Start up time | t_str | - | - | 2.0 | ms | Until frequency has been reached within ±0.5 x 10 ⁻⁶ of final freq. |
| | | - | - | 1.0 | ms | Until output signal has been reached min 90 % of final amp. |
| Harmonics | - | - | - | -5.0 | dBc | 3rd harmonics |

[For other general specifications, please refer to the attached Full Data Sheet below]

High stability and Low phase noise temperature compensated crystal oscillator (TCXO)**Product name : TG2016SMN / TG2520SMN****Features**

- High stability
- Frequency range : 10 MHz to 55 MHz
- Output : Clipped Sine
- Supply voltage : 1.7 V to 3.63 V
- Frequency / temperature characteristic : $\pm 0.5 \times 10^{-6}$ Max.
- Operating temperature : -40 °C to +85 °C
- Phase Noise : -161 dBc/Hz (fo = 26 MHz, 100 kHz offset)

Applications

- GNSS
- RF
- Wireless communication devices
- LTE, WiMAX, Wi-Fi, W-LAN
- IoT etc..



TG2016SMN
(2.0 × 1.6 × 0.73 mm)



TG2520SMN
(2.5 × 2.0 × 0.8 mm)

Description

TG2016SMN / TG2520SMN are high stability and low phase noise TCXOs using an Epson-developed and fabricated IC and MHz fundamental crystal .

The phase noise is the lowest of Epson's compact TCXO products lineup, making it an ideal reference clock for GNSS and other wireless communication devices.

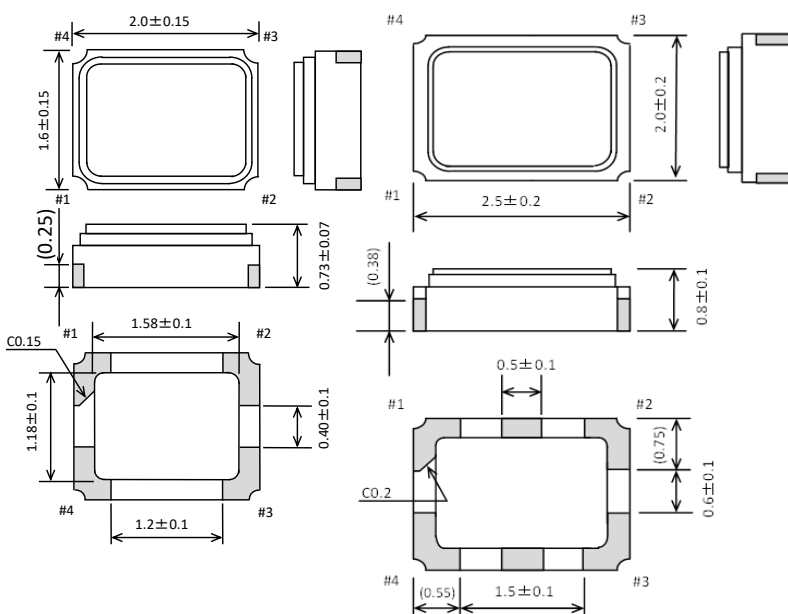
Outline dimensions**TG2016SMN****TG2520SMN****Characteristics****Frequency / temperature characteristics**

fo = 26 MHz, n = 40 pcs

**Frequency slope**

fo = 26 MHz, n = 40 pcs

**Pin information**

| Pin # | Connection |
|-------|--------------------------|
| 1 | N.C. (TCXO) |
| | V _C (VC-TCXO) |
| 2 | GND |
| 3 | OUT |
| 4 | V _{CC} |

[1] Product Number / Product Name

(1) Product Name (Standard Form)

TG2016 S MN 26.000000MHz E C G N N M

① ② ③ ④ ⑤ ⑥ ⑦ ⑧ ⑨

①Model (TG2016, TG2520) ②Output (S: Clipped sine) ③Frequency ④Supply voltage (Refer to symbol table)

⑤Frequency / temperature characteristics (C: $\pm 0.5 \times 10^{-6}$ Max., F: $\pm 2.0 \times 10^{-6}$ Max.) ⑥Operating temperature (G: -40 °C to +85 °C)

⑦Standby function (N: Non) ⑧V_C function(Refer to symbol table, N: Non for TCXO) ⑨Internal identification code ("M" is default)

| ④Supply voltage[Vcc] .⑧Vc function[Vc] (Symbol table) | | | | | |
|---|-----------------------|-------|---------|-------|--------|
| Voltage [V] | TCXO | | VC-TCXO | | |
| ④Vcc (Typ.) | E:1.8 M:2.8 to 3.3 | E:1.8 | B:2.8 | A:3.0 | C:3.3 |
| ⑧Vc (Typ.) | N: Non | B 0.9 | C:1.4 | D 1.5 | E 1.65 |

(2) Product Number / Ordering Code

[Please refer to the web site for the latest information](#)

| Frequency | Part number | | | |
|-----------|---|-----------------------------------|---|-----------------------------------|
| [MHz] | TG2520SMN (Size: 2.5 x 2.0) | | TG2016SMN (Size: 2.0 x 1.6) | |
| | ±0.5 ppm (-40 to +85 °C), without VC function | | ±0.5 ppm (-40 to +85 °C), without VC function | |
| | V _{CC} = 1.8 V | V _{CC} = 2.66 to 3.465 V | V _{CC} = 1.8 V | V _{CC} = 2.66 to 3.465 V |
| | Suffix: ECGNNM | Suffix: MCGNNM | Suffix: ECGNNM | Suffix: MCGNNM |
| 16 | X1G005421020827 | X1G005421030827 | X1G005441020825 | X1G005441030825 |
| 16.368 | X1G005421020127 | X1G005421030127 | X1G005441020125 | X1G005441030125 |
| 16.369 | X1G005421020227 | X1G005421030227 | X1G005441020225 | X1G005441030225 |
| 19.2 | X1G005421020327 | X1G005421030327 | X1G005441020325 | X1G005441030325 |
| 20 | X1G005421021127 | X1G005421031127 | X1G005441021125 | X1G005441031125 |
| 24 | X1G005421021227 | X1G005421031227 | X1G005441021225 | X1G005441031225 |
| 25 | X1G005421021327 | X1G005421031327 | X1G005441021325 | X1G005441031325 |
| 26 | X1G005421020427 | X1G005421030427 | X1G005441020425 | X1G005441030425 |
| 27 | X1G005421021427 | X1G005421031427 | X1G005441021425 | X1G005441031425 |
| 27.6 | X1G005421022127 | X1G005421032127 | X1G005441022125 | X1G005441032125 |
| 30 | X1G005421021527 | X1G005421031527 | X1G005441021525 | X1G005441031525 |
| 32 | X1G005421020527 | X1G005421030527 | X1G005441020525 | X1G005441030525 |
| 38.4 | X1G005421020627 | X1G005421030627 | X1G005441020625 | X1G005441030625 |
| 40 | X1G005421020727 | X1G005421030727 | X1G005441020725 | X1G005441030725 |
| 48 | X1G005421021627 | X1G005421031627 | X1G005441021625 | X1G005441031625 |
| 50 | X1G005421022227 | X1G005421032227 | X1G005441022225 | X1G005441032225 |
| 52 | X1G005421022027 | X1G005421032027 | X1G005441022025 | X1G005441032025 |

[2] Absolute maximum ratings

| Parameter | Symbol | Specifications | | | Unit | Conditions |
|---------------------------|----------------------|----------------|------|-----------------------|------|---------------------------|
| | | Min. | Typ. | Max. | | |
| Supply voltage | V _{CC} -GND | -0.5 | - | +4.0 | V | |
| Frequency control voltage | V _c -GND | -0.5 | - | V _{CC} + 0.5 | V | V _c Terminal |
| Storage temperature range | T _{stg} | -40 | - | +90 | °C | Storage as single product |

[3] Recommended operating conditions

| Parameter | Symbol | Specifications | | | Unit | Conditions |
|-----------------------------|-------------------|----------------|------|------|------|---------------------------------|
| | | Min. | Typ. | Max. | | |
| Supply voltage | V _{CC} | 1.7 | 1.8 | 1.9 | V | V _{CC} = 1.8 V ± 0.1 V |
| | | -5 % | 2.8 | +5 % | V | V _{CC} = 2.8 V ± 5 % |
| | | -5 % | 3.0 | +5 % | V | V _{CC} = 3.0 V ± 5 % |
| | | -5 % | 3.3 | +5 % | V | V _{CC} = 3.3 V ± 5 % |
| Supply voltage | GND | 0 | - | 0 | V | |
| Frequency control voltage | V _c | GND | N.C | — | V | V _c Terminal / TCXO |
| | | 0.3 | 0.9 | 1.5 | V | V _c = 0.9 V ± 0.6 V |
| | | 0.4 | 1.4 | 2.4 | V | V _c = 1.4 V ± 1.0 V |
| | | 0.5 | 1.5 | 2.5 | V | V _c = 1.5 V ± 1.0 V |
| | | 0.65 | 1.65 | 2.65 | V | V _c = 1.65 V ± 1.0 V |
| Operating temperature range | T _{use} | -40 | +25 | +85 | °C | |
| Output load | Load _R | 9 | 10 | 11 | kΩ | |
| | Load _C | 9 | 10 | 11 | pF | |
| | C _c | 0.01 | - | - | μF | DC-cut capacitor * |

* DC-cut capacitor is not included in this TCXO. Please attach an external DC-cut capacitor to the out pin.

[4] Frequency characteristics

(4-1) Frequency characteristics

(V_{CC} = Typ., V_c = Typ., Output Load = 10 kΩ // 10 pF, T_{use} = +25 °C)

| Parameter | Symbol | Specifications | | | Unit | Conditions |
|---|---------------------------------|--|------|------|-------------------|--|
| | | Min. | Typ. | Max. | | |
| Output Frequency | f _o | 10 | - | 55 | MHz | Standard Frequency |
| | | 16, 16.368, 16.369, 19.2, 20, 24, 25, 26, 27, 27.6, 30, 32, 38.4, 40, 48, 50, 52 | | | | |
| Frequency tolerance(before reflow) | f _{tol} | -0.5 | - | +0.5 | x10 ⁻⁶ | T _{use} = +25 °C ± 2 °C Before reflow |
| Frequency tolerance(after reflow) * | f _{tol} | -1.5 | - | +1.5 | x10 ⁻⁶ | T _{use} = +25 °C ± 2 °C After reflow * |
| Frequency / temperature characteristics | f _o -T _c | -0.5 | - | +0.5 | x10 ⁻⁶ | T _{use} = -40 °C to +85 °C (Reference to +25 °C) |
| Frequency / load coefficient | f _o -Load | -0.1 | - | +0.1 | x10 ⁻⁶ | Load ± 10 % |
| Frequency / voltage coefficient | f _o -V _{CC} | -0.1 | - | +0.1 | x10 ⁻⁶ | V _{CC} ± 5 % ** |
| Frequency aging_1year *** | f _{age_1y} | -0.5 | - | +0.5 | x10 ⁻⁶ | 10 MHz, 12 MHz ≤ f _o ≤ 20 MHz, 24 MHz ≤ f _o ≤ 40 MHz, |
| Frequency aging_3year | f _{age_3y} | -1.5 | - | +1.5 | x10 ⁻⁶ | |
| Frequency aging_5year | f _{age_5y} | -2.0 | - | +2.0 | x10 ⁻⁶ | |
| Frequency aging_10year | f _{age_10y} | -3.5 | - | +3.5 | x10 ⁻⁶ | |
| Frequency aging_1year *** | f _{age_1y} | -1.5 | - | +1.5 | x10 ⁻⁶ | 10 MHz < f _o < 12 MHz, 20 MHz < f _o < 24 MHz, 40 MHz < f _o ≤ 55 MHz |
| Frequency aging_3year | f _{age_3y} | -2.5 | - | +2.5 | x10 ⁻⁶ | |
| Frequency aging_5year | f _{age_5y} | -3 | - | +3 | x10 ⁻⁶ | |
| Frequency aging_10year | f _{age_10y} | -5 | - | +5 | x10 ⁻⁶ | |

* Measured in the elapse of 2 hours after reflow soldering.

** V_{CC} ± 5 % must be in operating supply voltage range (1.7 V to 3.63 V)

*** Aging stability is estimated from environmental reliability tests; expected amount of the frequency variation.

This does not intend to guarantee the product-life cycle

(4-2) Frequency control characteristics *VC-TCXO only ($V_{CC} = \text{Typ.}$, $V_c = \text{Typ.}$, Output Load = 10 k Ω // 10 pF, $T_{\text{use}} = +25\text{ }^{\circ}\text{C}$)

| Parameter | Symbol | Specifications | | | Unit | Conditions |
|---------------------------|--------|-------------------|------|------|------------------|---|
| | | Min. | Typ. | Max. | | |
| Frequency control range | f_cont | - | - | -5.0 | $\times 10^{-6}$ | $V_c = 0.9\text{ V} - 0.6\text{ V}$ at $V_{CC} = 1.8\text{ V}$ $V_c = 1.4\text{ V} - 1.0\text{ V}$ at $V_{CC} = 2.8\text{ V}$ $V_c = 1.5\text{ V} - 1.0\text{ V}$ at $V_{CC} = 3.0\text{ V}$ $V_c = 1.65\text{ V} - 1.0\text{ V}$ at $V_{CC} = 3.3\text{ V}$ |
| | | +5.0 | - | - | $\times 10^{-6}$ | $V_c = 0.9\text{ V} + 0.6\text{ V}$ at $V_{CC} = 1.8\text{ V}$ $V_c = 1.4\text{ V} + 1.0\text{ V}$ at $V_{CC} = 2.8\text{ V}$ $V_c = 1.5\text{ V} + 1.0\text{ V}$ at $V_{CC} = 3.0\text{ V}$ $V_c = 1.65\text{ V} + 1.0\text{ V}$ at $V_{CC} = 3.3\text{ V}$ |
| Input impedance | Zin | 500 | - | - | k Ω | Vc-GND (DC) |
| Frequency change polarity | - | Positive polarity | | | - | |

[5] Electrical characteristics ($V_{CC} = \text{Typ.}$, $V_c = \text{Typ.}$, Output Load = 10 k Ω // 10 pF, $T_{\text{use}} = +25\text{ }^{\circ}\text{C}$)

| Parameter | Symbol | Specifications | | | Unit | Conditions |
|---------------------------|-----------------|----------------|------|-------|------------------|--|
| | | Min. | Typ. | Max. | | |
| Current consumption | I _{CC} | - | - | 1.5 | mA | 10 MHz \leq fo \leq 26 MHz |
| | | - | - | 1.8 | mA | 26 MHz < fo \leq 40 MHz |
| | | - | - | 2.0 | mA | 40 MHz < fo \leq 50 MHz |
| | | - | - | 2.1 | mA | 50 MHz < fo \leq 55 MHz |
| Output voltage | Vpp | 0.8 | - | - | Vpp | Peak to peak voltage |
| Start-up time | t_str | - | - | 1.0 | ms | Until output signal has been reached min 90% of final amp. |
| Start-up time | t_str | - | - | 2.0 | ms | Until frequency has been reached within $\pm 0.5 \times 10^{-6}$ of final frequency. |
| Frequency drift rate | fo-dfift | - | - | 0.050 | $\times 10^{-6}$ | from 0.1 s to 0.6 s |
| | | - | - | 0.014 | | from 0.6 s to 1.6 s |
| | | - | - | 0.005 | | from 1.6 s and up to 40 s |
| Symmetry | SYM | 40 | 50 | 60 | % | GND level (DC-cut) |
| Harmonics | Hm | - | - | -10.0 | dBc | |
| Phase noise fo = 26 MHz * | L(f) | - | -66 | - | dBc/Hz | 1 Hz offset |
| | | - | -94 | - | | 10 Hz offset |
| | | - | -120 | - | | 100 Hz offset |
| | | - | -142 | - | | 1 kHz offset |
| | | - | -157 | - | | 10 kHz offset |
| | | - | -161 | - | | 100 kHz offset |
| | | - | -163 | - | | 1 MHz offset |

* For other frequencies, refer to Charts (6-8), Phase Noise

[6] Characteristic Data

(6-1) "Frequency / temperature characteristics" & "Frequency slope"

16.368 MHz (n = 40 pcs)



19.2 MHz (n = 40 pcs)



24 MHz (n = 40 pcs)

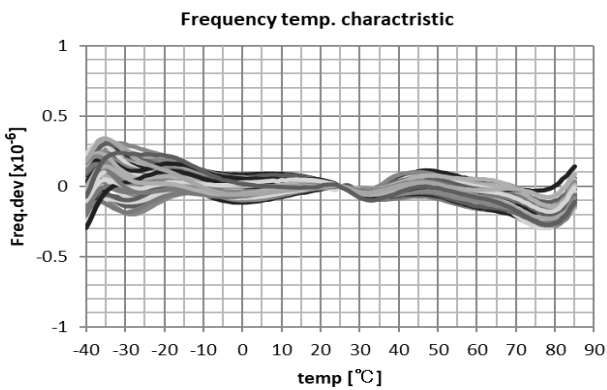

26 MHz (n = 40 pcs)

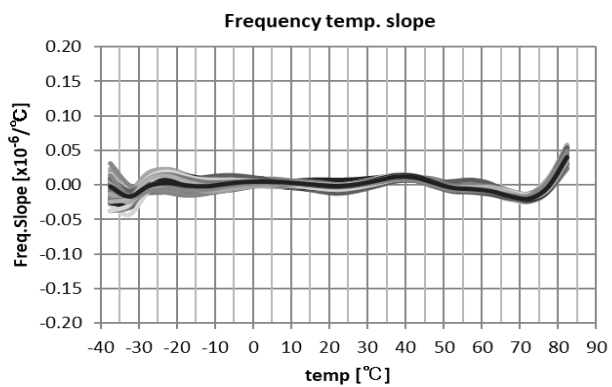
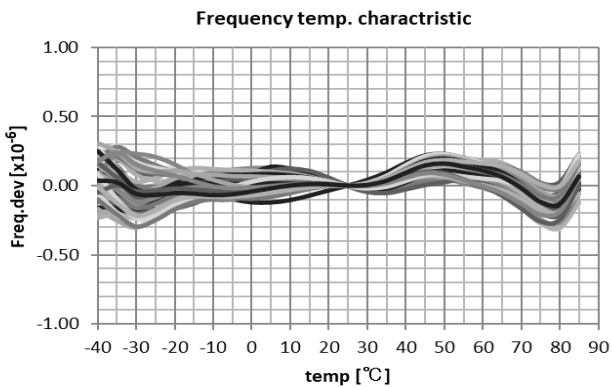

32 MHz (n = 40 pcs)



38.4 MHz (n = 40 pcs)

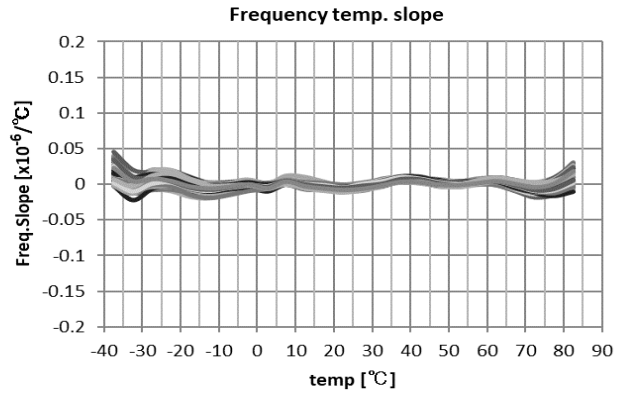
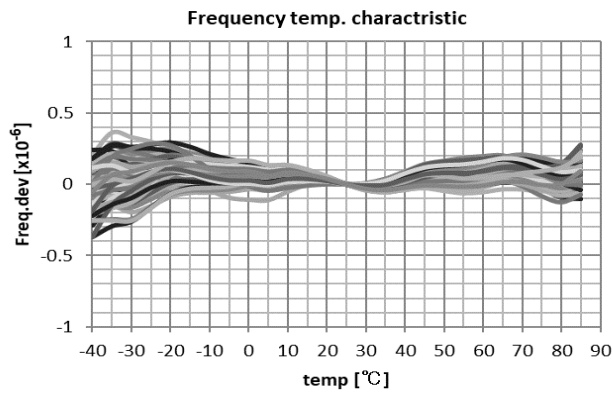

48 MHz (n = 40 pcs)

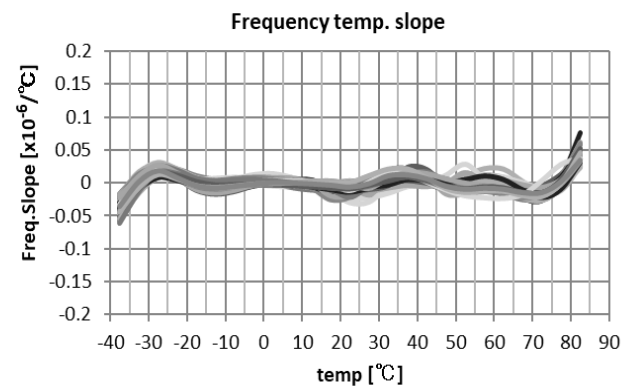
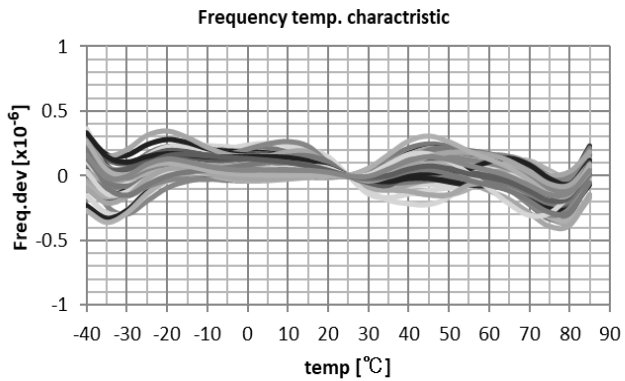

52 MHz (n = 40 pcs)

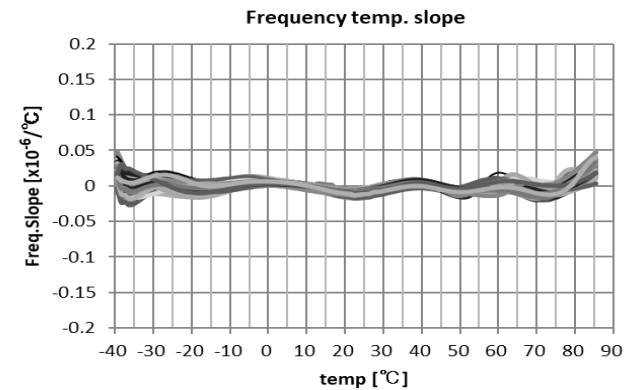
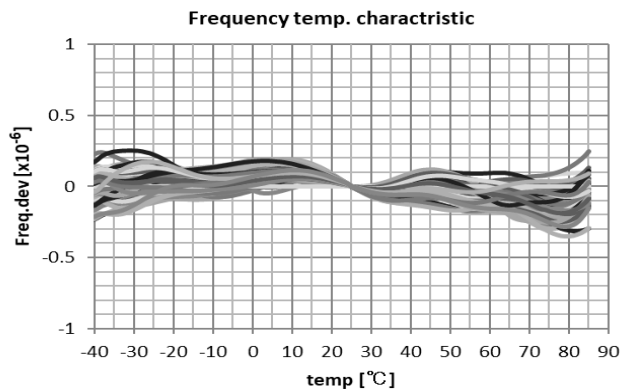

(6-2) "Frequency / load coefficient" & "Frequency / voltage coefficient"

26 MHz

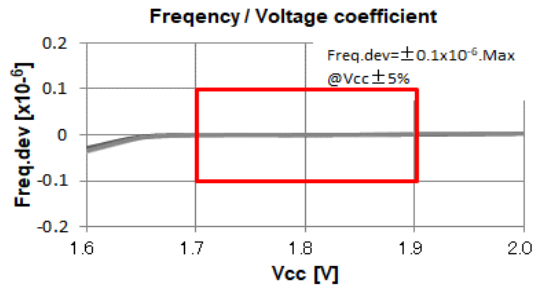
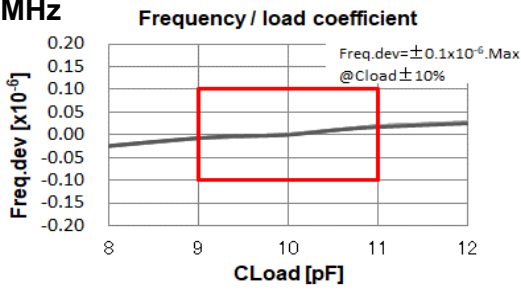

55 MHz

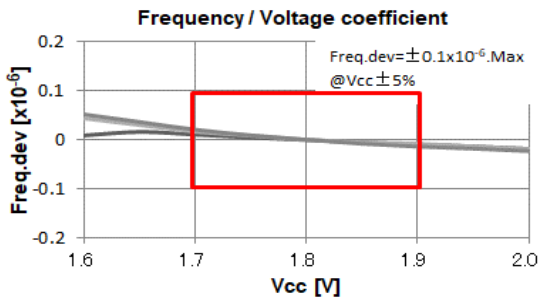
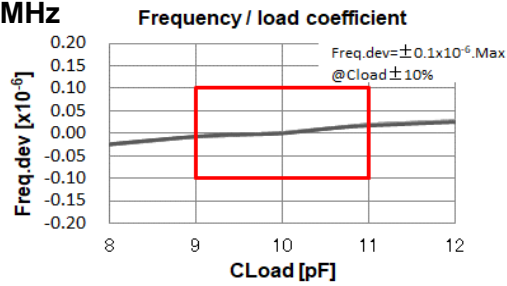

(6-3) Frequency Aging

*Aging stability is estimated from environmental reliability tests; expected amount of the frequency variation.
This does not intend to guarantee the product-life cycle.

26 MHz Accelerated Aging Test (n = 20 pcs)

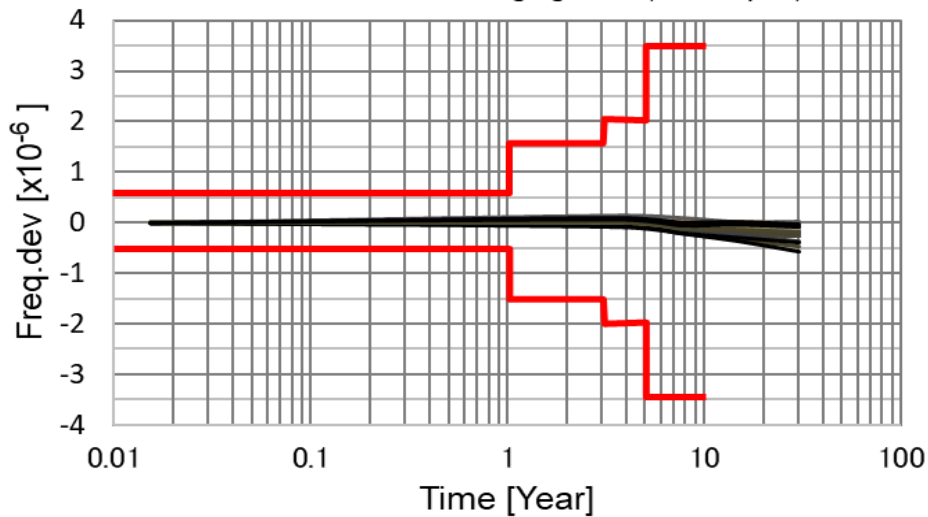

(6-4) G-sensitivity (26 MHz)

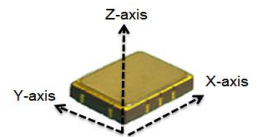
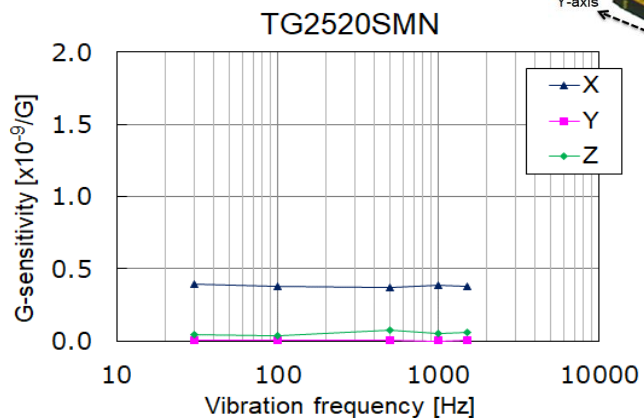
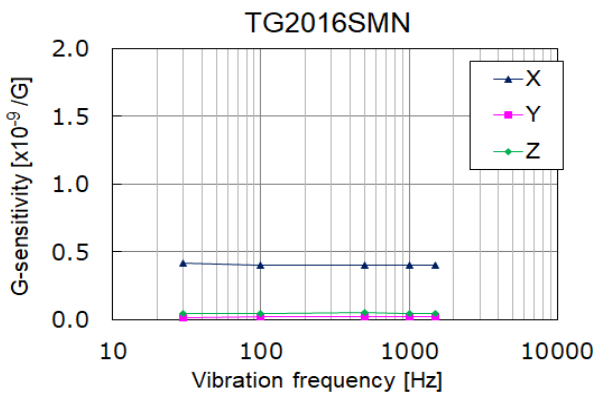

(6-5) Frequency control range (26 MHz, T_{use} = 25 °C, VC-TCXO only)

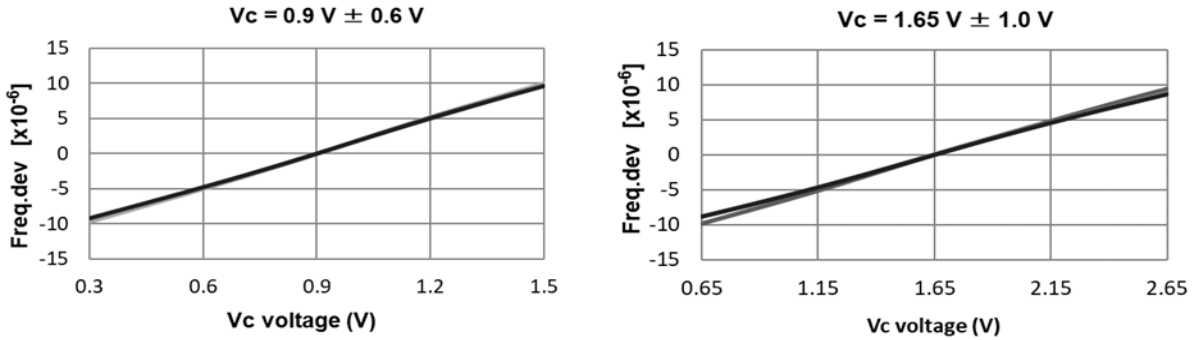

(6-6) "Current consumption" & "Output voltage peak to peak" (T_{use} = 25 °C)

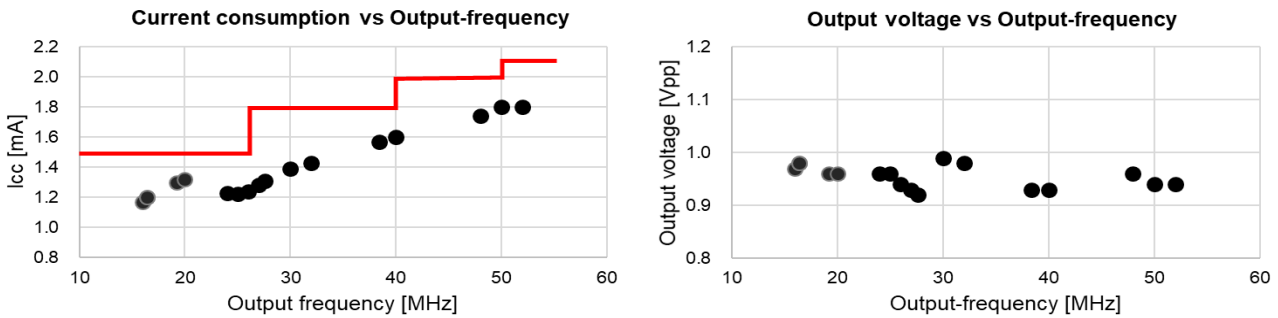

(6-7) Start-up time (T_{use} = 25 °C, X axis Scale = 0.2 msec/div)

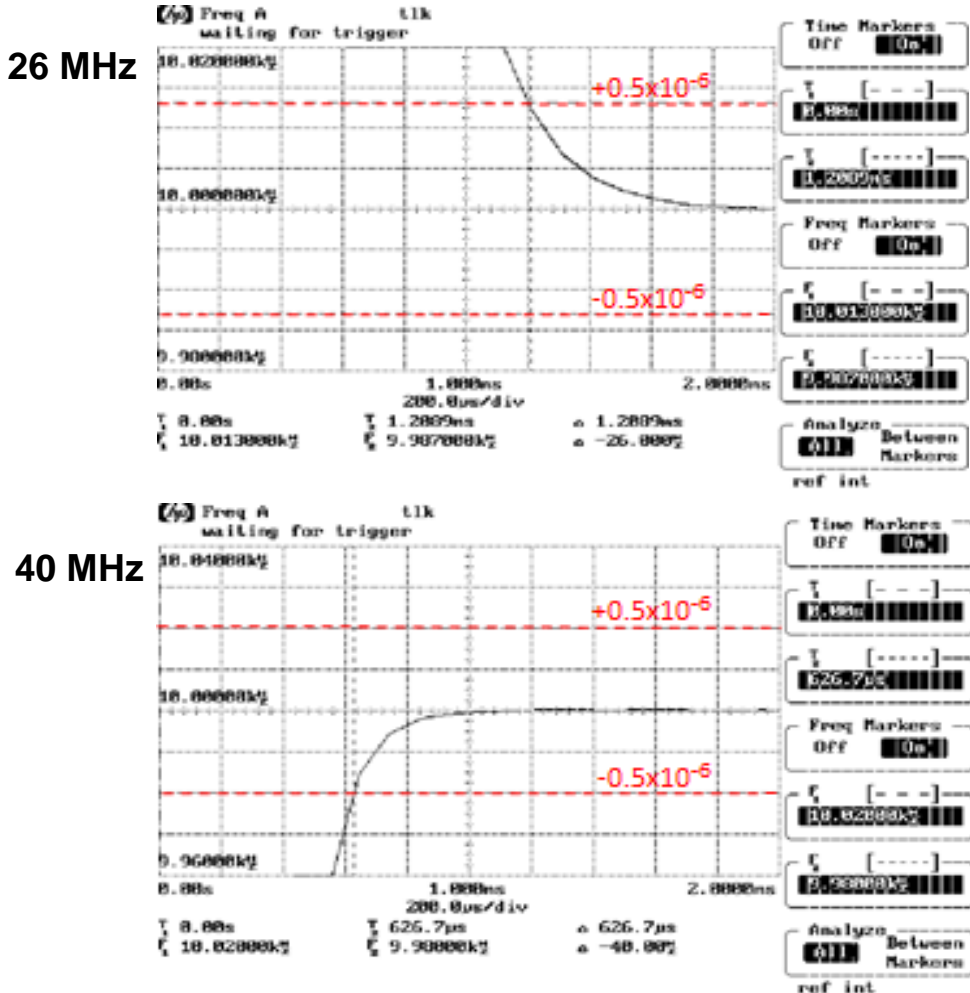

(6-8) Phase Noise

(1) fo = 16 MHz, T_use = +25 °C, n = 5 pcs



(2) fo = 16.368 MHz, T_use = +25 °C, n = 5 pcs

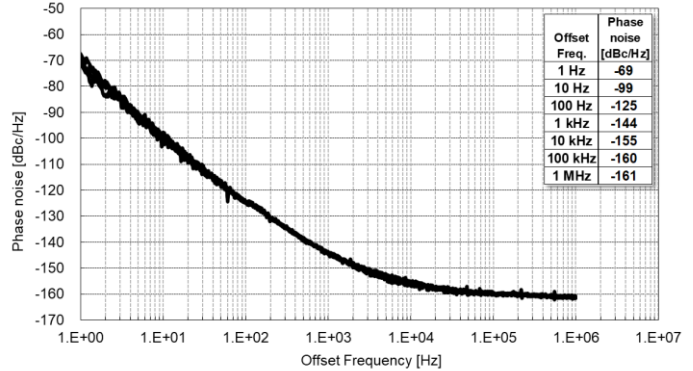

(3) fo = 16.369 MHz, T_use = +25 °C, n = 5 pcs

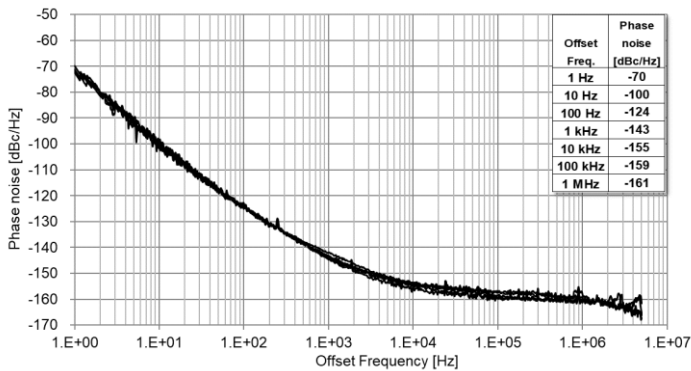

(4) fo = 19.2 MHz, T_use = +25 °C, n = 5 pcs

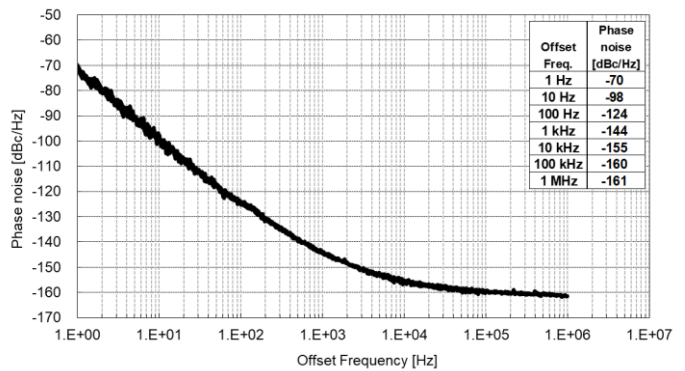

(5) fo = 20 MHz, T_use = +25 °C, n = 5 pcs

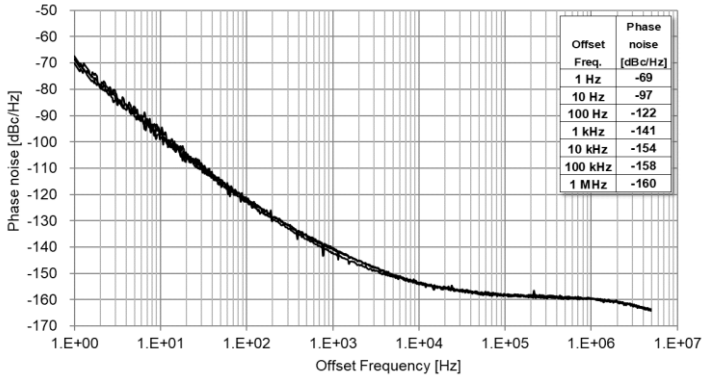

(6) fo = 24 MHz, T_use = +25 °C, n = 5 pcs

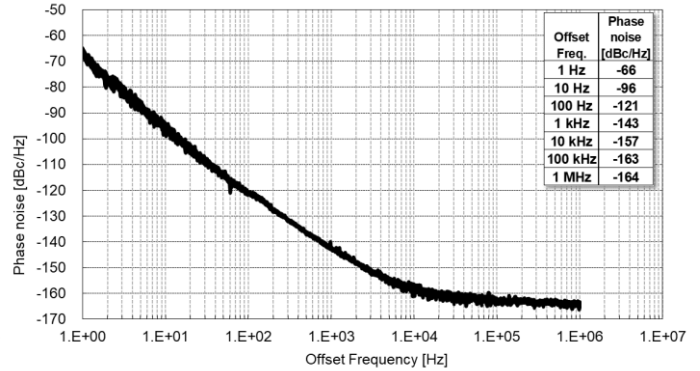

(7) fo = 25 MHz, T_use = +25 °C, n = 5 pcs

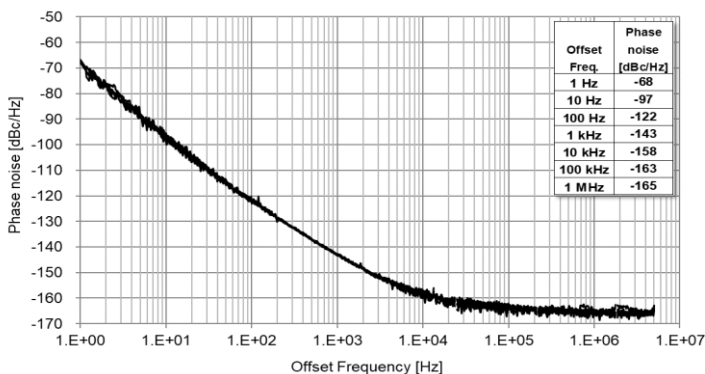

(8) fo = 26 MHz, T_use = +25 °C, n = 5 pcs

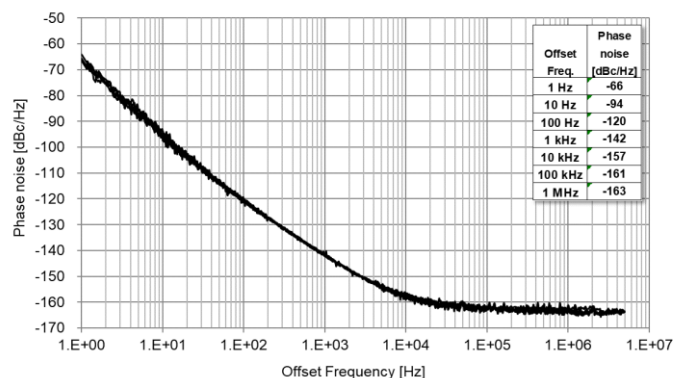

(6-8) Phase Noise

(9) fo = 27 MHz, T_use = +25 °C, n = 5 pcs

(10) fo = 27.6 MHz, T_use = +25 °C, n = 5 pcs



(11) fo = 30 MHz, T_use = +25 °C, n = 5 pcs

(12) fo = 32 MHz, T_use = +25 °C, n = 5 pcs

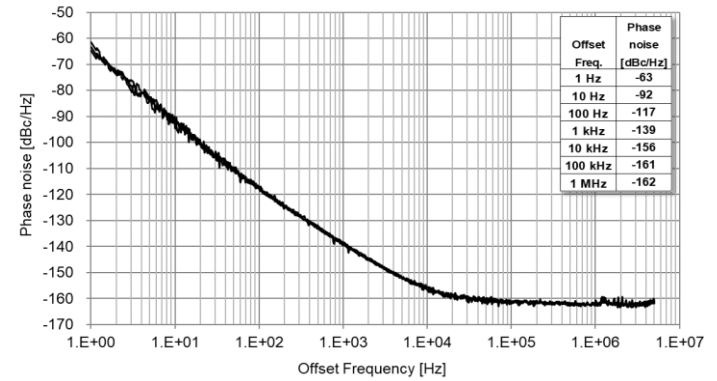
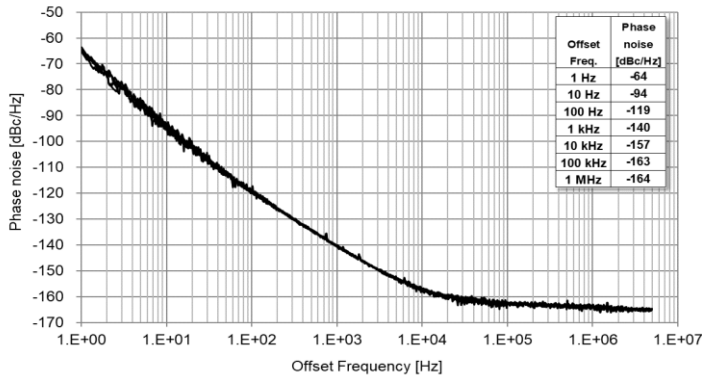

(13) fo = 38.4 MHz, T_use = +25 °C, n = 5 pcs

(14) fo = 40 MHz, T_use = +25 °C, n = 5 pcs

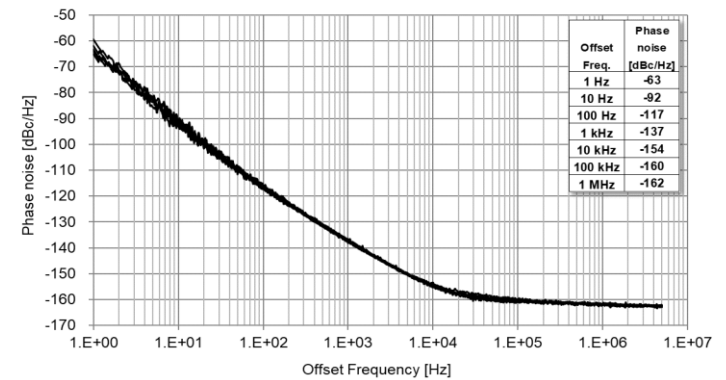

(15) fo = 48 MHz, T_use = +25 °C, n = 5 pcs

(16) fo = 52 MHz, T_use = +25 °C, n = 5 pcs

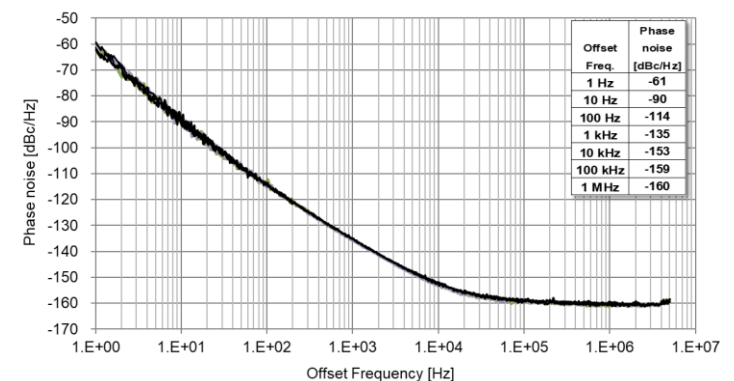

(6-9) Short term stability [ADEV] (26 MHz, n = 18 pcs)



[7] Test circuit

(7-1) Output Load : Load = 10 kΩ // 10 pF

(1)TCXO Connection Example



(2)VC-TCXO Connection Example

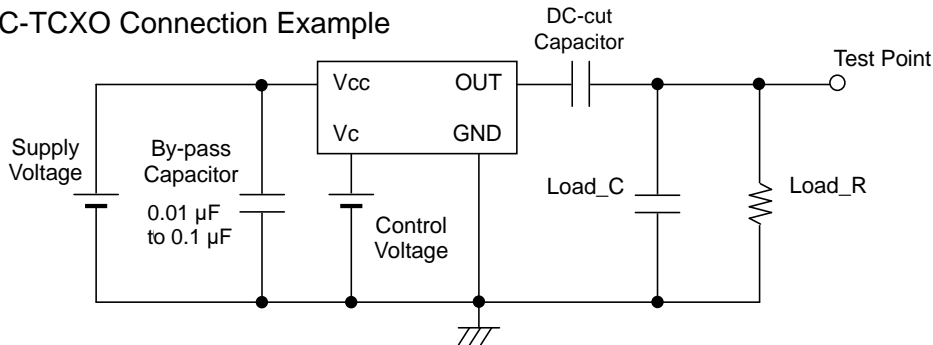

(7-2) Current Consumption

(1)TCXO Connection Example

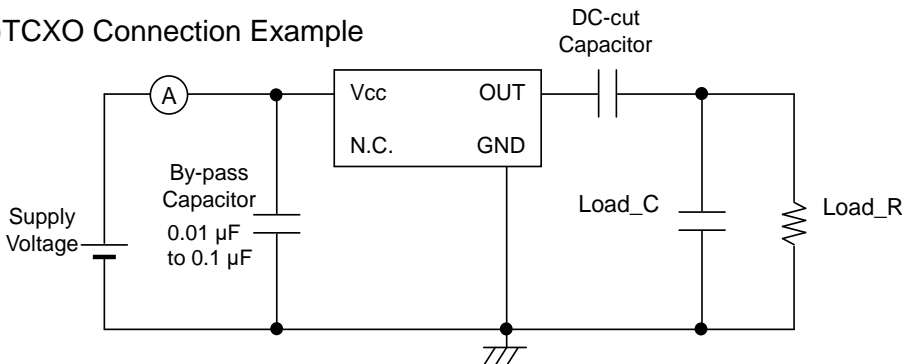

(2)VC-TCXO Connection Example



(7-3) Conditions

- (1) Oscilloscope: Impedance Min. 1 MΩ
Input capacitance Max. 10 pF
Band width Min. 300 MHz

Impossible to measure both frequency and wave form at the same time.

(In case of using oscilloscope's amplifier output, possible to measure both at the same time.)

- (2) Load_C includes probe capacitance.
- (3) A capacitor (By-pass: 0.01 μF to 0.1 μF) is placed between V_{CC} and GND, and closely to TCXO.
- (4) Use the current meter whose internal impedance value is small.
- (5) Power Supply Impedance of power supply should be as low as possible.

[8] Outline Drawing / Recommended Foot Print
(1)TG2016SMN

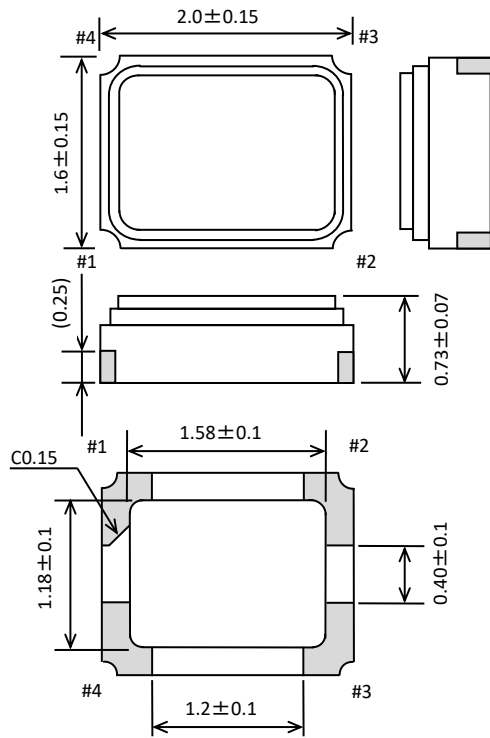

Terminal coating : Au plating

(2)TG2520SMN

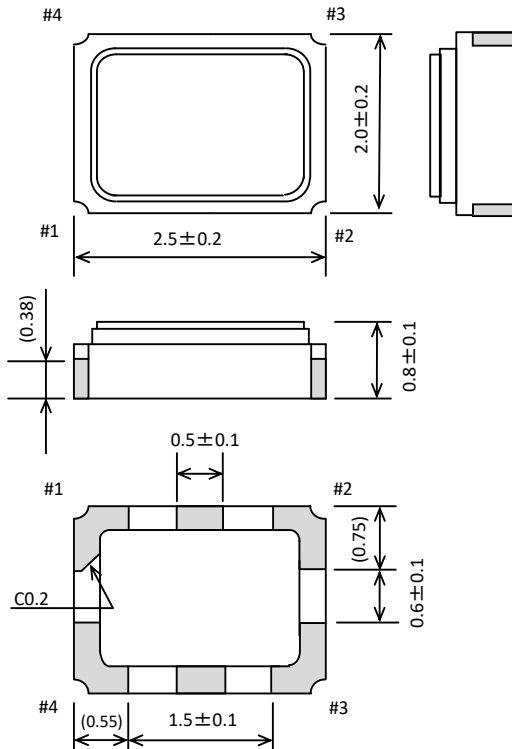

Terminal coating : Au plating

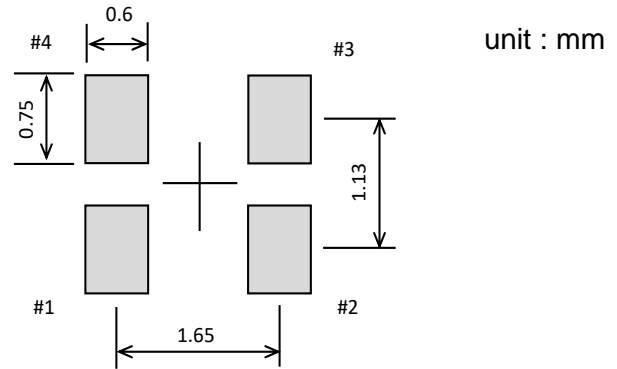

| Pin # | Connection |
|-------|-----------------------------|
| 1 | N.C. (TCXO) Vc (VC-TCXO) |
| 2 | GND |
| 3 | OUT |
| 4 | V _{CC} |

Please keep "N.C." pin OPEN condition or GND connection.

"N.C." pin doesn't work as a ground pin.

For stable operation, please add a bypass capacitor($0.01 \mu\text{F}$ to $0.1 \mu\text{F}$) between V_{CC} and GND. Please place it as close to TCXO as possible.

Please do not place any pattern between footprint pads.

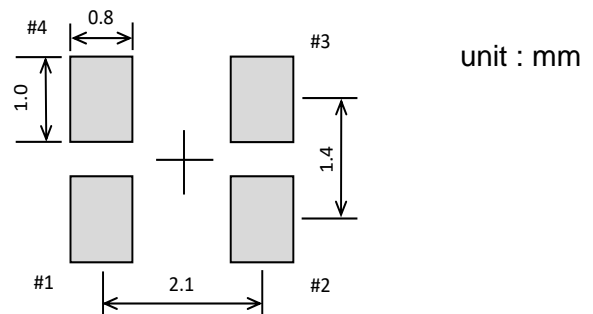

| Pin # | Connection |
|-------|----------------------------|
| 1 | N.C (TCXO) Vc (VC-TCXO) |
| 2 | GND |
| 3 | OUT |
| 4 | V _{CC} |

Please keep "N.C." pin OPEN condition or GND connection.

"N.C." pin doesn't work as a ground pin.

For stable operation, please add a bypass capacitor($0.01 \mu\text{F}$ to $0.1 \mu\text{F}$) between V_{CC} and GND. Please place it as close to TCXO as possible.

Please do not place any pattern between footprint pads.

[9] Marking

TG2016SMN / TG2520SMN common

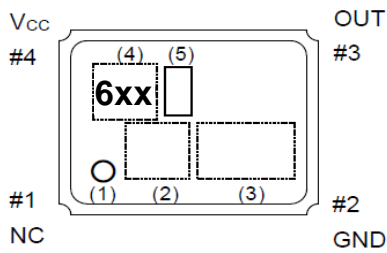

- (1) 1Pin Mark
- (2) Arbitrary marking area (2digits)
- (3) Lot No. (3digits)
- (4) model ID
- (5) Image recognition mark

【Model ID Example】

| product | Freq.[MHz] | (4)model ID |
|-----------|------------|-------------|
| TG2016SMN | 16.368 | 6A0 |
| TG2016SMN | 16.369 | 6A1 |
| TG2016SMN | 19.2 | 6A2 |
| TG2016SMN | 26 | 6A3 |
| TG2016SMN | 32 | 6A4 |
| TG2016SMN | 38.4 | 6A5 |
| TG2016SMN | 40 | 6A6 |

[10] Moisture Sensitivity Level , Electro-Static Discharge

(10-1) Moisture Sensitivity Level (MSL)

| Parameter | Specifications | Conditions |
|-----------|----------------|------------------|
| MSL | LEVEL1 | JEDEC J-STD-020D |

(10-2) Electro-Static Discharge (ESD)

| Parameter | Specifications | Conditions |
|------------------------|----------------|---|
| Human Body Model (HBM) | 2 000 V Min. | EIAJ ED-4701-1 C111A, 100 pF, 1.5 kΩ, 3 times |
| Machine Model (MM) | 200 V Min. | EIAJ ED-4701-1 C111, 200 pF, 0 Ω, 1 time |

[11] Reflow Profile (follow to IPC / JEDEC J-STD-020D.1)

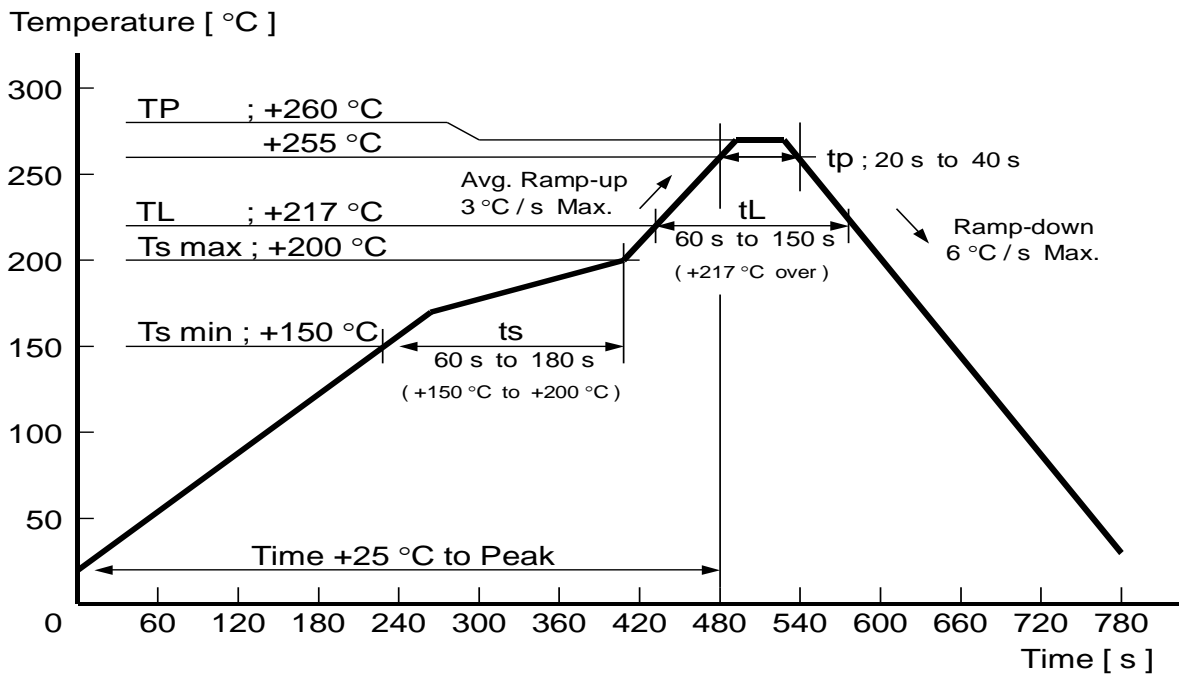

[12] Packing Information

TG2016SMN

(12-1) Product number last 2 digits code(**xx**) define Quantity. The standard is "25", 12 000 pcs/Reel.
 X1G005441xxxx**xx**

(12-2) Taping Specification

Subject to EIA-481 & IEC-60286

(1) Tape Dimensions TE0804L

Material of the Carrier Tape : PS Material of the Top Tape : PET+PE

unit : mm

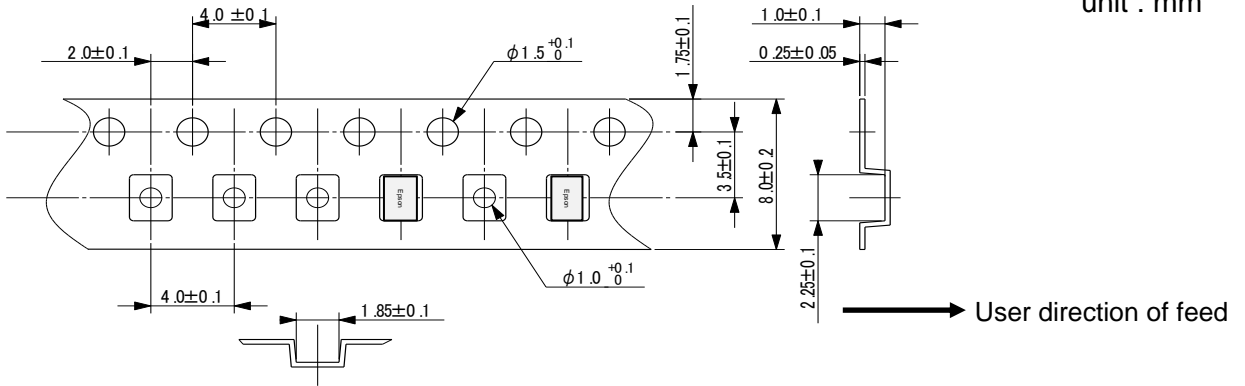

TG2520SMN

(12-1) Product number last 2 digits code(**xx**) define Quantity. The standard is "27", 10 000 pcs/Reel.
 X1G005421xxxx**xx**

(12-2) Taping Specification

Subject to EIA-481 & IEC-60286

(1) Tape Dimensions TE0804L

Material of the Carrier Tape : PS

Material of the Top Tape : PET+PE

unit : mm

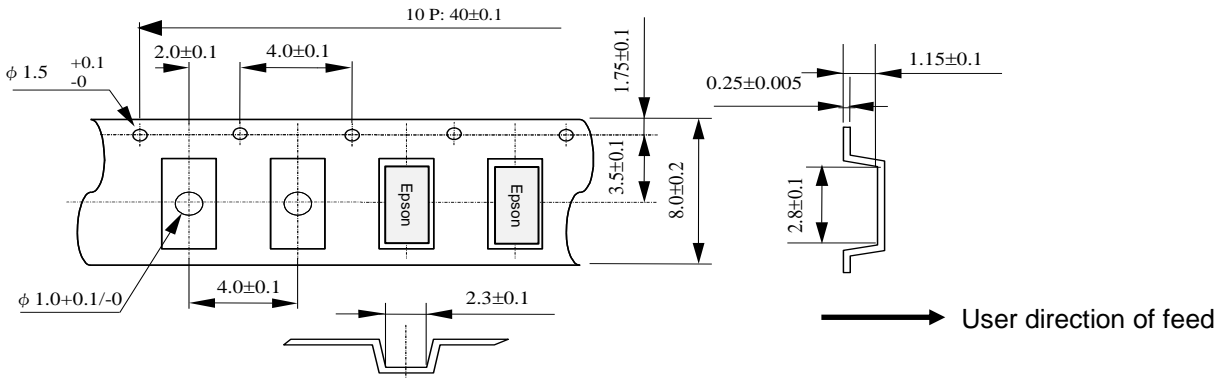

TG2016SMN / TG2520SMN Common

(2) Reel Dimensions

Center material : PS

Material of the Reel : PS

unit : mm

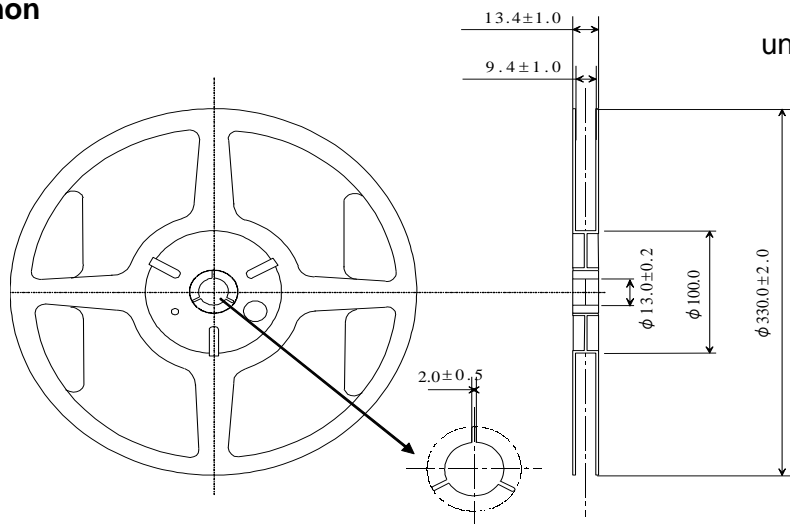

[13] Handling Precautions

Prior to using this product, please carefully read the section entitled "Precautions" on our Web site (<https://www5.epsondevice.com/en/information/#precaution>) for instructions on how to handle and use the product properly to ensure optimal performance of the product in your equipment.

Before using the product under any conditions other than those specified therein, please consult with us to verify and confirm that the performance of the product will not be negatively affected by use under such conditions.

In addition to the foregoing precautions, in order to avoid the deteriorating performance of the product, we strongly recommend that you DO NOT use the product under ANY of the following conditions:

- (1) Do not expose this product to excessive mechanical shock or vi
- (2) This product can be damaged by mechanical shock during the soldering process depending on the equipment used, process conditions, and any impact forces experienced. Always follow appropriate procedures, particularly when changing the assembly process in anyway and be sure to follow applicable process qualification standards before starting production.
- (3) These devices are sensitive to ESD, please use appropriate precautions during handling, assembly, test, shipment, and installation.
- (4) This product contains semiconductor content that should not be exposed to electromagnetic waves.
- (5) The use of ultrasonic technology for cleaning, bonding, etc. can damage the Xtal unit inside this product. Please carefully check for this consideration before using ultrasonic equipment for volume production with this product.
- (6) Noise and ripple on the power supply may have undesirable affects on operation and cause degradation of phase noise characteristics. Evaluate the operation of this device with appropriate power supplies carefully before use.
- (7) When applying power, ensure that the supply voltage increases monotonically for proper operation. On power down, do not reapply power until the supplies, bypass capacitors, and any bulk capacitors are completely discharged since that may cause the unit to malfunction.
- (8) Aging specifications are estimated from environmental reliability tests and expected frequency variation over time. They do not provide a guarantee of aging over the product lifecycle.
- (9) The metal cap on top of the device is directly connected to the GND terminal (pin #2). Take necessary precautions to prevent any conductor not at ground potential from contacting the cap as that could cause a short circuit t
- (10) Do not route any signal lines, supply voltage lines, or GND lines underneath the area where the oscillators are mounted including any internal layers and on the opposite side of the PCB. To avoid any issues due to interference of other signal lines, please take care not to place signal lines near the product as this may have an adverse affect on the performance of the product.
- (11) A bypass capacitor of the recommended value(s) must be connected between the V_{CC} and GND terminals of the product. Whenever possible, mount the capacitor(s) on the same side of the PCB and as close to the product as possible to keep the routing traces short.
- (12) Power supply connections to V_{cc} and GND pins should be routed as thick as possible while keeping the high frequency impedance low in order to get the best performance.
- (13) The use of a filter or similar element in series with the power supply connections to protect from electromagnetic radiation noise may increase the high frequency impedance of the power supply line and may cause the oscillator to not operate properly. Please verify the design to ensure sufficient operational margin prior to use.
- (14) Keep PCB routing from the output terminal(s) to the load as short as possible for best performance.
- (15) Do not short the output to GND as that will damage the product. Always use with an appropriate load resistor connected.
- (16) Product failures during the warranty period only apply when the product is used according to the recommended operating conditions described in the specifications. Products that have been opened for analysis or damaged will not be covered. It is recommended to store and use in normal temperature and humidity environments described in the specifications to ensure frequency accuracy and prevent moisture condensation. If the product is stored for more than one year, please confirm the pin solderability prior to use.
- (17) If the oscillation circuit is exposed to condensation, the frequency may change or oscillation may stop. Do not use in any conditions where condensation occurs.
- (18) Do not store or use the product in an environment where it can be exposed to chemical substances that are corrosive to metal or plastics such as salt water, organic solvents, chemical gasses, etc. Do not use the product when it is exposed to sunlight, dust, corrosive gasses, or other materials for long periods of time.
- (19) When using water-soluble solder flux make sure to completely remove the flux residue after soldering. Pay particular attention when the residues contain active halogens which will negatively affect the product and its performance.
- (20) Do not touch the surface of the IC with tweezers or other hard tools.
- (21) Do not use adhesives with this product as this will cause the oscillation to stop if the IC is damaged by adhesive. This product uses an underfill material on the bottom side of package where adhesive near the bottom side may cause the TCXO to be damaged by thermal expansion.

PROMOTION OF ENVIRONMENTAL MANAGEMENT SYSTEM CONFORMING TO INTERNATIONAL STANDARDS

At Seiko Epson, all environmental initiatives operate under the Plan-Do-Check-Action (PDCA) cycle designed to achieve continuous improvements. The environmental management system (EMS) operates under the ISO 14001 environmental management standard.

All of our major manufacturing and non-manufacturing sites, in Japan and overseas, completed the acquisition of ISO 14001 certification.



ISO 14000 is an international standard for environmental management that was established by the International Standards Organization in 1996 against the background of growing concern regarding global warming, destruction of the ozone layer, and global deforestation.

WORKING FOR HIGH QUALITY

In order provide high quality and reliable products and services than meet customer needs, Seiko Epson made early efforts towards obtaining ISO9000 series certification and has acquired ISO9001 for all business establishments in Japan and abroad. We have also acquired IATF 16949 certification that is requested strongly by major manufacturers as standard.

IATF 16949 is the international standard that added the sector-specific supplemental requirements for automotive industry based on ISO9001.

■ Explanation of marks used in this datasheet

| | |
|---|--|
|  | <p>●Pb free.</p> |
|  | <p>●Complies with EU RoHS directive. *About the products without the Pb-free mark. Contains Pb in products exempted by EU RoHS directive (Contains Pb in sealing glass, high melting temperature type solder or other)</p> |

NOTICE: PLEASE READ CAREFULLY BELOW BEFORE THE USE OF THIS DOCUMENT ©Seiko Epson Corporation 2020

- The content of this document is subject to change without notice. Before purchasing or using Epson products, please contact with sales representative of Seiko Epson Corporation ("Epson") for the latest information and be always sure to check the latest information published on Epson's official web sites and resources.
- This document may not be copied, reproduced, or used for any other purposes, in whole or in part, without Epson's prior consent.
- Information provided in this document including, but not limited to application circuits, programs and usage, is for reference purpose only. Epson makes no guarantees against any infringements or damages to any third parties' intellectual property rights or any other rights resulting from the information. This document does not grant you any licenses, any intellectual property rights or any other rights with respect to Epson products owned by Epson or any third parties.
- Using Epson products, you shall be responsible for safe design in your products; that is, your hardware, software, and/or systems shall be designed enough to prevent any critical harm or damages to life, health or property, even if any malfunction or failure might be caused by Epson products. In designing your products with Epson products, please be sure to check and comply with the latest information regarding Epson products (including, but not limited to this document, specifications, data sheets, manuals, and Epson's web site). Using technical contents such as product data, graphic and chart, and technical information, including programs, algorithms and application circuit examples under this document, you shall evaluate your products thoroughly both in stand-alone basis and within your overall systems. You shall be solely responsible for deciding whether to adopt/use Epson products with your products.
- Epson has prepared this document carefully to be accurate and dependable, but Epson does not guarantee that the information is always accurate and complete. Epson assumes no responsibility for any damages you incurred due to any misinformation in this document.
- No dismantling, analysis, reverse engineering, modification, alteration, adaptation, reproduction, etc., of Epson products is allowed.
- Epson products have been designed, developed and manufactured to be used in general electronic applications and specifically requires particular quality or extremely high reliability in order to refrain from causing any malfunction or failure leading to critical harm to life and health, serious property damage, or severe impact on society, including, but not limited to listed below ("Specific Purpose"). Therefore, you are strongly advised to use Epson products only for the Anticipated Purpose. Should you desire to purchase and use Epson products for Specific Purpose, Epson makes no warranty and disclaims with respect to Epson products, whether express or implied, including without limitation any implied warranty of merchantability or fitness for any Specific Purpose. Please be sure to contact our sales representative in advance, if you desire Epson products for Specific Purpose:
Space equipment (artificial satellites, rockets, etc.)/ Transportation vehicles and their control equipment (automobiles, aircraft, trains, ships, etc.) / Medical equipment/ Relay equipment to be placed on sea floor/ Power station control equipment / Disaster or crime prevention equipment/Traffic control equipment/ Financial equipment
Other applications requiring similar levels of reliability as the above
- Epson products listed in this document and our associated technologies shall not be used in any equipment or systems that laws and regulations in Japan or any other countries prohibit to manufacture, use or sell. Furthermore, Epson products and our associated technologies shall not be used for the purposes of military weapons development (e.g. mass destruction weapons), military use, or any other military applications. If exporting Epson products or our associated technologies, please be sure to comply with the Foreign Exchange and Foreign Trade Control Act in Japan, Export Administration Regulations in the U.S.A (EAR) and other export-related laws and regulations in Japan and any other countries and to follow their required procedures.
- Epson assumes no responsibility for any damages (whether direct or indirect) caused by or in relation with your non-compliance with the terms and conditions in this document or for any damages (whether direct or indirect) incurred by any third party that you give, transfer or assign Epson products.
- For more details or other concerns about this document, please contact our sales representative.
- Company names and product names listed in this document are trademarks or registered trademarks of their respective companies.