

MHz Range Crystal unit

- Package size (1.0 mm × 0.8 mm × 0.3 mm)
- Fundamental mode
- Reference weight Typ. 0.9 mg

[1] Product Number / Product Name / Marking

(1-1) Product Number / Ordering Code

X1E0004510007xx

Last 2 digits code(xx) defines Quantity.

The standard is "26", 6 000 pcs/Reel.

(1-2) Product Name / Model Name

FA1008AN 59.970000 MHz 8.0 +10.0-10.0

[2] Absolute maximum ratings

Parameter	Symbol	Specifications			Unit	Conditions
		Min.	Typ.	Max.		
Storage temperature	T_stg	-40	-	+125	°C	Storage as single product
Operating temperature range	T_use	-40	-	+105	°C	-

[3] Specifications(characteristics)

Parameter	Symbol	Specifications			Unit	Conditions
		Min.	Typ.	Max.		
Nominal frequency	f_nom	—	59.970000	—	MHz	Fundamental
Frequency tolerance	f_tol	-10	-	+10	x 10 ⁻⁶	@+25°C
Frequency Stability over temperature	f_tem	-15	-	+15	x 10 ⁻⁶	-30°C to +85°C
Operating temperature	T_use	-30	-	+85	°C	
Level of drive	DL	0.01	-	100	μW	Recommended: 10 μW
Load capacitance	CL	—	8	—	pF	
Motional resistance (ESR)	R1	-	-	60	Ω	
Motional capacitance	C1	-	1.25	-	fF	
Motional inductance	L1	-	5.66	-	mH	
Shunt capacitance	C0	-	0.31	-	pF	
Frequency aging	f_age	-1	—	+1	x10 ⁻⁶ /yea	@+25°C, First year

[For other general specifications, please refer to the attached Full Data Sheet below]

Tiny Size MHz range crystal unit: Product Name: FA1008AN

Features

- Package size: 1.0 x 0.8 mm t = 0.3 mm Max.
- Frequency range: 40 MHz to 100 MHz
(Currently avail: 52 MHz, 59.97 MHz)
- Frequency tolerance: $\pm 10 \times 10^{-6}$ (+25 °C)
- Frequency vs. temperature characteristics:
 - $\pm 10 \times 10^{-6}$ (-20 to +75 °C)
 - $\pm 15 \times 10^{-6}$ (-30 to +85 °C)
 - $\pm 20 \times 10^{-6}$ (-40 to +85 °C)
- ESR: 60 Ω Max. (52 MHz, 59.97 MHz)

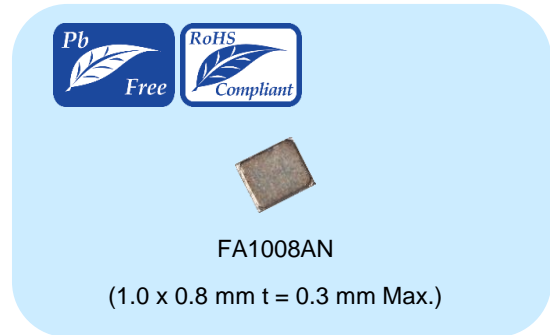

Applications

- Wearables, Smart speakers, Digital health
- Smartphone, Tablets, PCs
- General Consumer Electronics/Appliances
- Industrial IoT, Meter, Light/Building monitoring
- Enables wireless communication:
 - BLE, Wi-Fi, NB-IoT, etc.

Description

FA1008AN is tiny size enabling designers to save board space without compromising performance.

The wide MHz frequency up to 100MHz and operating temperature up to 105 °C(option*1) serve the popular wireless communication protocols for consumer and industrial IoT applications, making the FA1008AN ideal for devices and modules pushing the limit on features and size.

*1 Please contact Epson about $T_{use} > +85$ °C

Outline Drawing

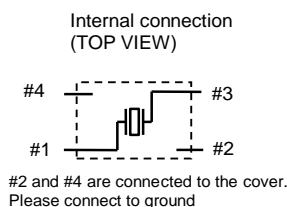
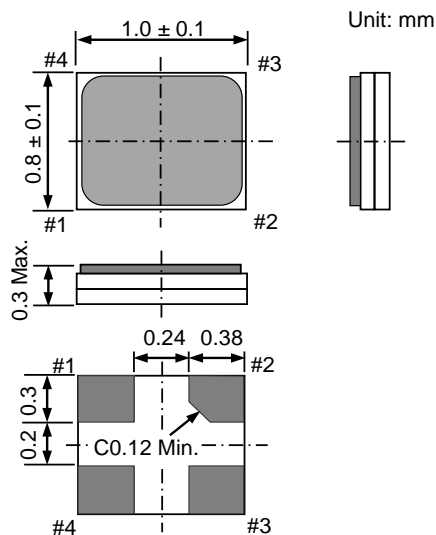

Terminal Assignment

Pin	Connection
#1	X'tal
#2	GND
#3	X'tal
#4	GND

Typical Performance

Frequency vs. Temperature characteristics
(Frequency = 59.97MHz, n = 50)

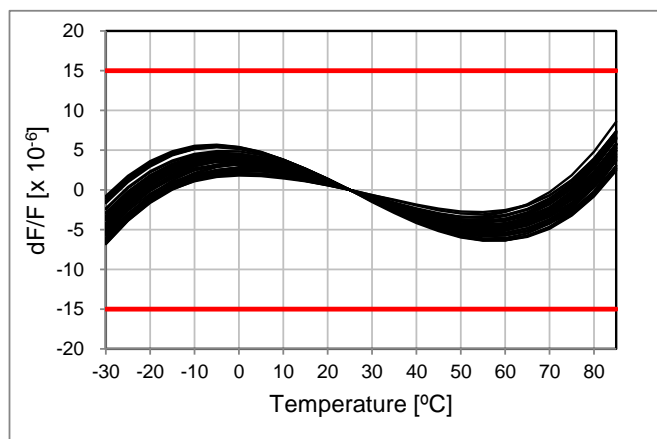

[1] Product Number / Product Name

(1-1) Product Number

X1E000451xxxx26 (Please contact Epson for details)

(1-2) Product Name (Standard Form)

FA1008AN 59.970000MHz 12.0 +10.0-10.0

a b c d

a: Model b: Frequency c: Load capacitance (pF) d: Frequency tolerance ($\times 10^{-6}$, +25 °C)

In addition to the mentioned above specification items ("a" to "d"),

Please specify the frequency temperature characteristics from "e" to "g" below

e: $\pm 10 \times 10^{-6}$ / -20 °C to +75 °C, f: $\pm 15 \times 10^{-6}$ / -30 °C to +85 °C, g: $\pm 20 \times 10^{-6}$ / -40 °C to +85 °C

[2] Absolute Maximum Ratings

Item	Symbol	Rating value			Unit	Note
		Min.	Typ.	Max.		
Storage temperature range	T_stg	-40	-	+125	°C	Satisfy environmental characteristics specifications

[3] Operating Conditions

Item	Symbol	Rating value			Unit	Note
		Min.	Typ.	Max.		
Operating temperature range	T_use	-40	-	+105	°C	Please contact Epson about T_use > +85 °C
Level of drive	DL	0.01	10	200	μ W	Recommended: 10 μ W

[4] Static Characteristics

Item	Symbol	Specifications			Unit	Conditions / Remarks
		Min.	Typ.	Max.		
Nominal frequency range	f_nom	40.000	-	100.000	MHz	Please contact Epson for frequencies other than those currently avail frequency
		52 / 59.97				Currently avail frequency
Frequency tolerance	f_tol	-10.0	-	+10.0	$\times 10^{-6}$	+25 °C ± 3 °C DL = 10 μ W Does not include frequency aging
Motional resistance (ESR)	R1	-	-	60	Ω	Currently avail frequency π circuit IEC 60444-2 T_use = -40 °C to +85 °C DL = 10 μ W
Shunt capacitance	C0	-	-	1.0	pF	π circuit and Network Analyzer
Frequency vs. temperature characteristics	f_tem	Please specify from Table 1.			$\times 10^{-6}$	Reference at +25 °C ± 3 °C
Load capacitance	CL	6	-	∞	pF	Please specify
Isolation resistance	IR	500	-	-	M Ω	
Frequency aging	f_age	-1.0	-	+1.0	$\times 10^{-6}$	Currently avail frequency +25°C , First year

Table 1. Frequency vs. temperature characteristics

Operating temperature range	Frequency temperature characteristics
-20 °C to +75 °C	$\pm 10 \times 10^{-6}$
-30 °C to +85 °C	$\pm 15 \times 10^{-6}$
-40 °C to +85 °C	$\pm 20 \times 10^{-6}$

*Please contact Epson for other than the above

[5] Example of frequency vs. temperature characteristics

(5-1) 52 MHz: $\pm 20 \times 10^{-6}$ / -40°C to 85°C

n = 50

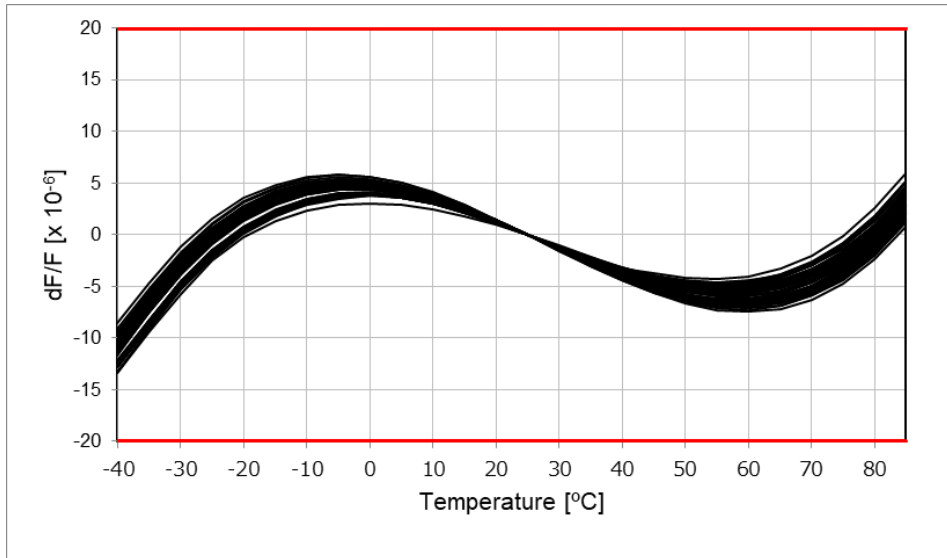
(5-2) 59.97 MHz: $\pm 15 \times 10^{-6}$ / -30°C to 85°C

n = 50

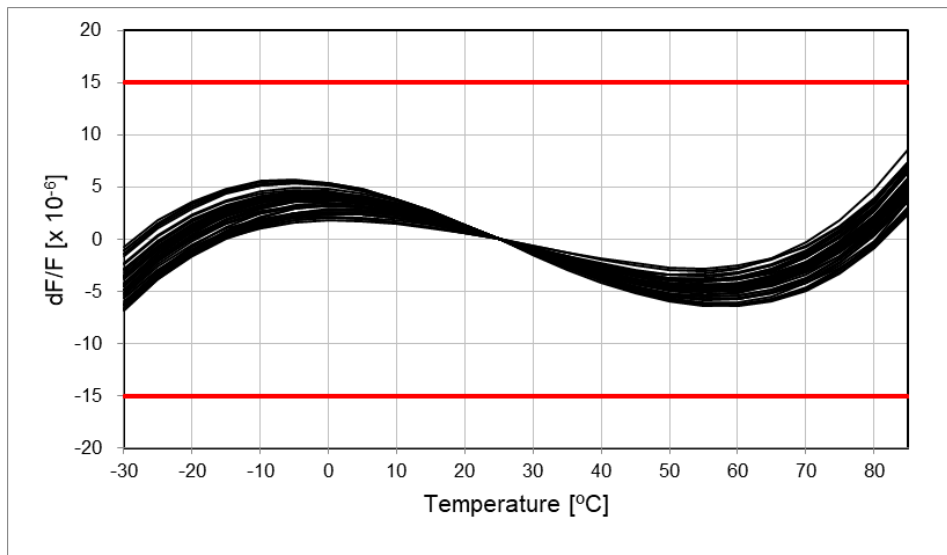

[6] Marking Description

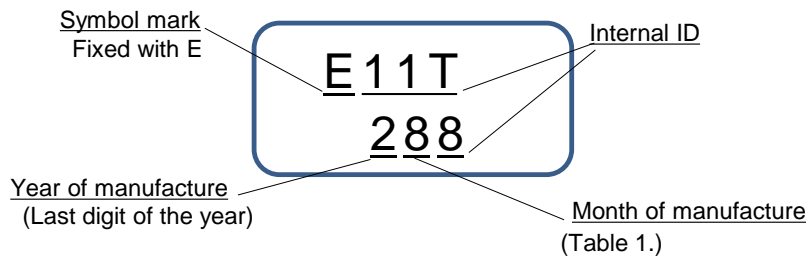
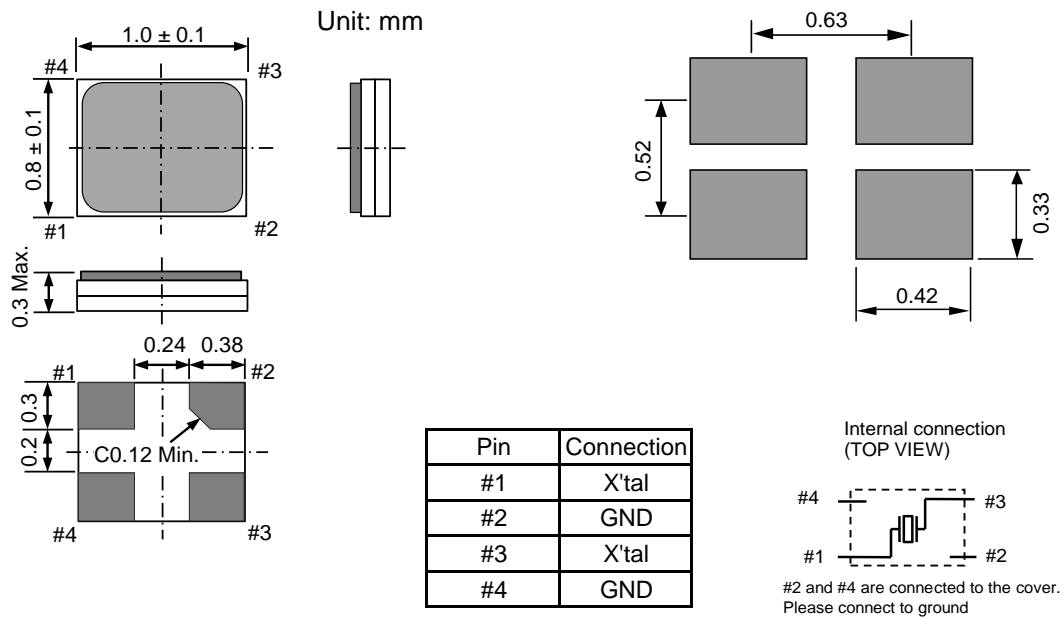

Table 1. Month of manufacture

Month	Jan	Feb	Mar	Apr	May	Jun	Jul	Aug	Sep	Oct	Nov	Dec
Code	1	2	3	4	5	6	7	8	9	X	Y	Z

[7] Outline Drawing and Recommended Footprint



Reference weight Typ.: 0.776 mg
Terminal coating: Au plating

[8] Moisture Sensitivity Level and Electro-Static Discharge Ratings

(8-1) Moisture Sensitivity Level (MSL)

Parameter	Specification	Conditions
MSL	LEVEL1	IPC/JEDEC J-STD-020E

[9] Reflow Profile

IPC/JEDEC J-STD-020E

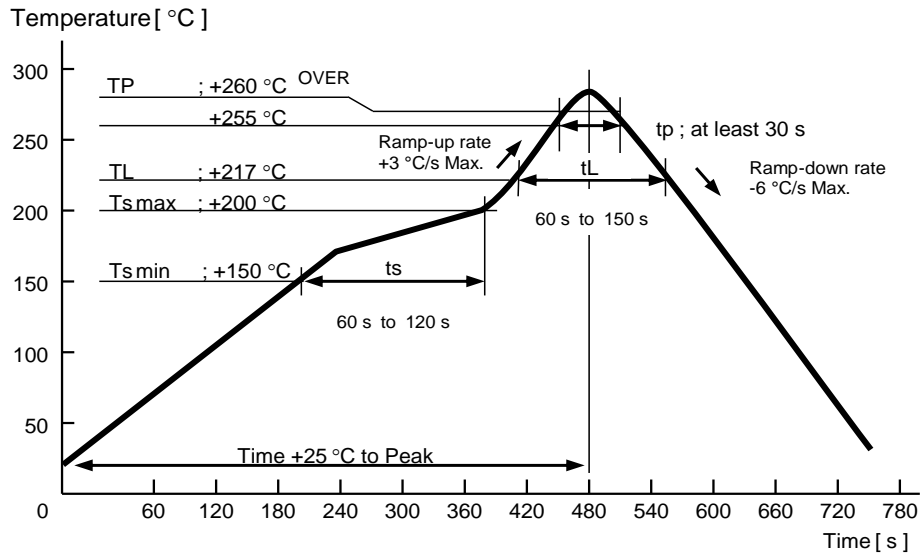

[10] Packing Information

(10-1) Packing Quantity

The last two digits of the Product Number (X1E000451xxxx26) defines the packing quantity.
The standard is "26" for a 6 000 pcs/Reel.

(10-2) Taping Specification

Subject to EIA-481, IEC 60286, JIS C0806

(1) Tape Dimensions

Carrier Tape Material: PS (Polystyrene)

Top Tape Material: PET (Polyethylene Terephthalate) + PE (Polyethylene)

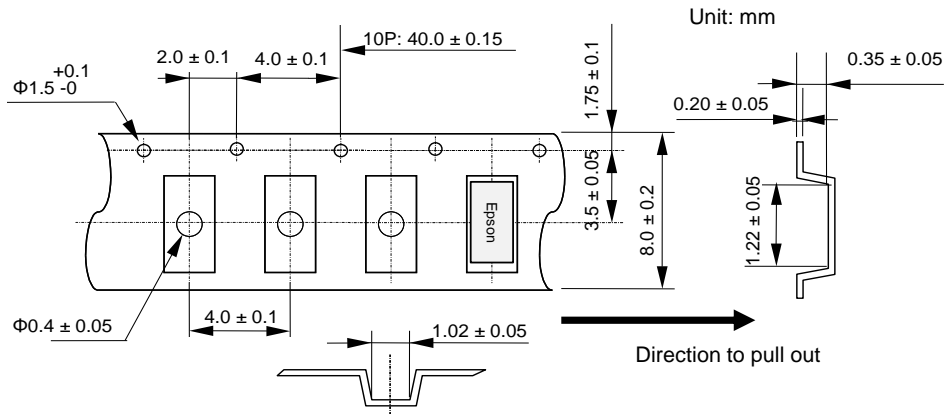

(2) Reel Dimensions

Center Material: PS (Polystyrene)

Reel Material: PS (Polystyrene)

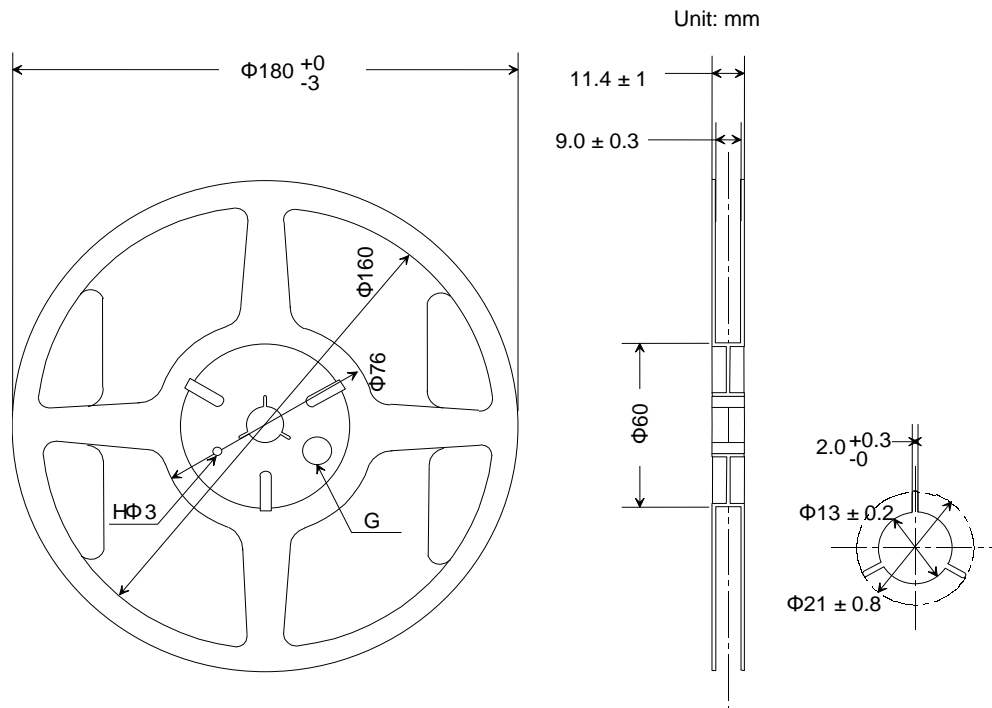

[11] Handling Precautions

Prior to using this product, please carefully read the section entitled "Precautions" on our Web site (<https://www5.epsondevice.com/en/information/#precaution>) for instructions on how to handle and use the product properly to ensure optimal performance of the product in your equipment.

Before using the product under any conditions other than those specified therein, please consult with Epson to verify and confirm that the performance of the product will not be negatively affected by use under such conditions.

In addition to the foregoing precautions, in order to avoid degrading the performance of the product, we strongly advise that you adhere to the below recommendations:

1. Limit reflow to 3 times.
This product has gone through AuSn melt sealing.
Reflow mounting is recommended instead of using a soldering iron or air heater.
When the product is removed from a PCB board or module with a soldering iron, please do so carefully as excess heat to the AuSn sealing material (melt point +278 °C) may deteriorate the seal and hermeticity.
2. Avoid using the products if it received any excessive shocks and vibrations.
Crystal products may be damaged under some conditions during mounting if exposed to excess shock.
Please set the mounting conditions to a slow mounting speed on the PCB to minimize shock as much as possible.
Please review the conditions after the changed are made.
3. Keep the electrode wiring as short as possible to ensure normal oscillation.
4. Store the crystal products at normal temperature (+15 °C to +35 °C) and humidity (25 %RH to 85 %RH)
Storing the crystal products under higher temperature or high humidity over one year may affect frequency stability or solderability.
Contact Epson before use if the product has been stored outside the conditions mentioned above.
5. Ultrasonic equipment used for cleaning or bonding may deteriorate the characteristics of the product.
Be sure to check in advance.
6. In high humidity environment, dew condensation on the PCB board may cause malfunction such frequency shift or no oscillation.
7. Applying excessive drive level to the crystal units may cause deterioration of characteristics or damage.
Design and test the circuit so that the proper drive level is maintained.
8. The characteristic such as frequency, etc. may differ from your measurement depending on the measurement method or conditions.
Contact Epson for any questions.
9. Do not route any signal lines, supply voltage lines, or GND lines underneath the area where the oscillators are mounted.
If shielding with GND is required, shield the side furthest from the oscillator circuit.
any internal layers and on the opposite side of the PCB. care not to place signal lines near the product as this may have an adverse affect on the performance of the product.
10. Use soldering paste <80 μm Max, the products are low profile specification.
11. Ensure adequate negative resistance is allocated in the oscillation circuit,
otherwise oscillation startup time may increase or no oscillation may occur.
In order to avoid this, provide enough negative resistance that is 5 time the motional resistance(R1)
12. Aging specifications are estimated from environmental reliability tests and expected frequency variation over time.
They do not provide a guarantee of aging over the product lifecycle.
13. Should any customer use the product in any manner contrary to the precautions and/or advice herein,
such use shall be done at the customer's own risk.

< Check of Negative resistance >

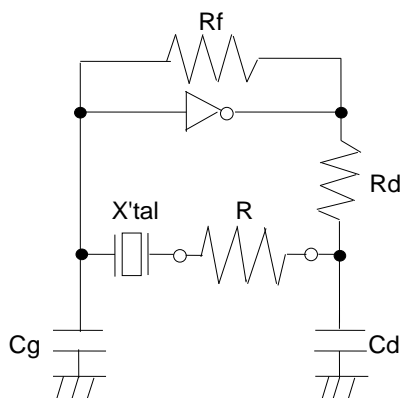

1. Connect the resistance (R) to the circuit in series with the crystal unit.
2. Adjust (R) so that oscillation can start (or stop).
3. Measure (R) when oscillation just starts (or stops) in (2) above.
4. Recommended(R)
 $R > R1 \times 5$

PROMOTION OF ENVIRONMENTAL MANAGEMENT SYSTEM CONFORMING TO INTERNATIONAL STANDARDS

At Seiko Epson, all environmental initiatives operate under the Plan-Do-Check-Action (PDCA) cycle designed to achieve continuous improvements. The environmental management system (EMS) operates under the ISO 14001 environmental management standard.

All of our major manufacturing and non-manufacturing sites, in Japan and overseas, completed the acquisition of ISO 14001 certification.



ISO 14000 is an international standard for environmental management that was established by the International Standards Organization in 1996 against the background of growing concern regarding global warming, destruction of the ozone layer, and global deforestation.

WORKING FOR HIGH QUALITY

In order provide high quality and reliable products and services than meet customer needs, Seiko Epson made early efforts towards obtaining ISO9000 series certification and has acquired ISO9001 for all business establishments in Japan and abroad. We have also acquired IATF 16949 certification that is requested strongly by major manufacturers as standard.

IATF 16949 is the international standard that added the sector-specific supplemental requirements for automotive industry based on ISO9001.

■ Explanation of marks used in this datasheet

	<p>● Pb free.</p>
	<p>● Complies with EU RoHS directive. *About the products without the Pb-free mark. Contains Pb in products exempted by EU RoHS directive (Contains Pb in sealing glass, high melting temperature type solder or other)</p>

NOTICE: PLEASE READ CAREFULLY BELOW BEFORE THE USE OF THIS DOCUMENT ©Seiko Epson Corporation 2020

- The content of this document is subject to change without notice. Before purchasing or using Epson products, please contact with sales representative of Seiko Epson Corporation ("Epson") for the latest information and be always sure to check the latest information published on Epson's official web sites and resources.
- This document may not be copied, reproduced, or used for any other purposes, in whole or in part, without Epson's prior consent.
- Information provided in this document including, but not limited to application circuits, programs and usage, is for reference purpose only. Epson makes no guarantees against any infringements or damages to any third parties' intellectual property rights or any other rights resulting from the information. This document does not grant you any licenses, any intellectual property rights or any other rights with respect to Epson products owned by Epson or any third parties.
- Using Epson products, you shall be responsible for safe design in your products; that is, your hardware, software, and/or systems shall be designed enough to prevent any critical harm or damages to life, health or property, even if any malfunction or failure might be caused by Epson products. In designing your products with Epson products, please be sure to check and comply with the latest information regarding Epson products (including, but not limited to this document, specifications, data sheets, manuals, and Epson's web site). Using technical contents such as product data, graphic and chart, and technical information, including programs, algorithms and application circuit examples under this document, you shall evaluate your products thoroughly both in stand-alone basis and within your overall systems. You shall be solely responsible for deciding whether to adopt/use Epson products with your products.
- Epson has prepared this document carefully to be accurate and dependable, but Epson does not guarantee that the information is always accurate and complete. Epson assumes no responsibility for any damages you incurred due to any misinformation in this document.
- No dismantling, analysis, reverse engineering, modification, alteration, adaptation, reproduction, etc., of Epson products is allowed.
- Epson products have been designed, developed and manufactured to be used in general electronic applications and specifically requires particular quality or extremely high reliability in order to refrain from causing any malfunction or failure leading to critical harm to life and health, serious property damage, or severe impact on society, including, but not limited to listed below ("Specific Purpose"). Therefore, you are strongly advised to use Epson products only for the Anticipated Purpose. Should you desire to purchase and use Epson products for Specific Purpose, Epson makes no warranty and disclaims with respect to Epson products, whether express or implied, including without limitation any implied warranty of merchantability or fitness for any Specific Purpose. Please be sure to contact our sales representative in advance, if you desire Epson products for Specific Purpose:
Space equipment (artificial satellites, rockets, etc.) / Transportation vehicles and their control equipment (automobiles, aircraft, trains, ships, etc.) / Medical equipment / Relay equipment to be placed on sea floor / Power station control equipment / Disaster or crime prevention equipment / Traffic control equipment / Financial equipment
Other applications requiring similar levels of reliability as the above
- Epson products listed in this document and our associated technologies shall not be used in any equipment or systems that laws and regulations in Japan or any other countries prohibit to manufacture, use or sell. Furthermore, Epson products and our associated technologies shall not be used for the purposes of military weapons development (e.g. mass destruction weapons), military use, or any other military applications. If exporting Epson products or our associated technologies, please be sure to comply with the Foreign Exchange and Foreign Trade Control Act in Japan, Export Administration Regulations in the U.S.A (EAR) and other export-related laws and regulations in Japan and any other countries and to follow their required procedures.
- Epson assumes no responsibility for any damages (whether direct or indirect) caused by or in relation with your non-compliance with the terms and conditions in this document or for any damages (whether direct or indirect) incurred by any third party that you give, transfer or assign Epson products.
- For more details or other concerns about this document, please contact our sales representative.
- Company names and product names listed in this document are trademarks or registered trademarks of their respective companies.