

1. **Device name** SPXO (Output specification C-MOS)
 2. **Type name** DSO221SXF
 3. **Nominal frequency** 100.000MHz

4. **Absolute maximum ratings**

Item	Symbol	Rating	Unit
Supply voltage	V _{cc}	-0.3 ~ +4.5	V
Storage temperature range	T _{stg}	-40 ~ +85	°C

5. **Electrical characteristics**

Item	Symbol	Limits			Unit	Condition	
		min.	typ.	max.			
Total frequency tolerance	F _{tol}	-30	-	+30	ppm	+3.3±0.3V	-40~+85°C
Operating temperature range	T _{use}	-40	-	+85	°C		-
Supply voltage	V _{cc}	+3.0	+3.3	+3.6	V	-	-40~+85°C
Current consumption (No load)	I _{cc}	-	-	10.0	mA		
Standby current (#1 Pin : "L" level)	I _{std}	-	-	0.01	mA		
Symmetry (Duty cycle)	SYM	45	-	55	%		
0 level voltage	V _{oL}	-	-	V _{cc} ×0.1	V		
1 level voltage	V _{oH}	V _{cc} ×0.9	-	-	V	+3.3V	+25±3°C
Rise & Fall time	t _r / t _f	-	-	3	ns		
Load condition	L _{cmos}	-	-	15	pF		
0 level input voltage	V _{iL}	-	-	V _{cc} ×0.3	V		
1 level input voltage	V _{iH}	V _{cc} ×0.7	-	-	V		
Output disable time	t _{PLZ}	-	-	200	ns		
Output enable time	t _{PZL}	-	-	2	ms		

Measurement circuit and output wave form is refer to Fig.1. and Fig.2.

TITLE DSO221SXF TYPE CRYSTAL OSCILLATOR SPECIFICATION		Remark		
Date 2023/06/19	Spec.No. 7FE10000A10	Rev. -	Page 1 / 10	

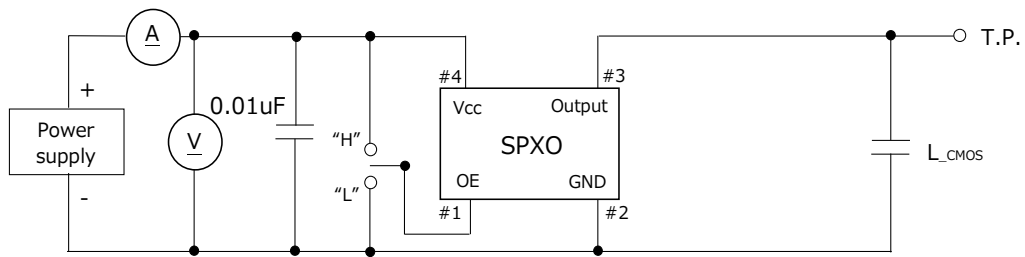

Function

#1 Input	#3 Output condition
H	Oscillation out
L	High Z

*L_cmos : Total fixture and probe capacitance
(Refer to Electric characteristics)

Fig.1 Measurement circuit

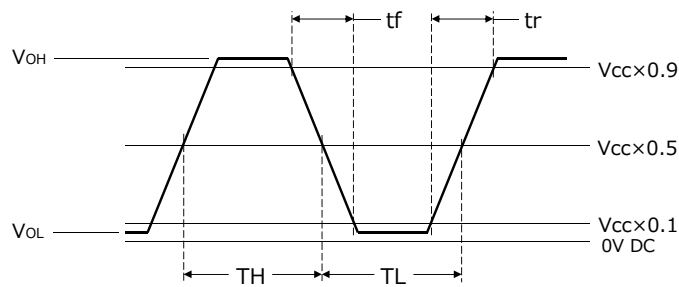

$$SYM = TH / (TH + TL) \times 100(\%)$$

Fig.2 Output wave Form

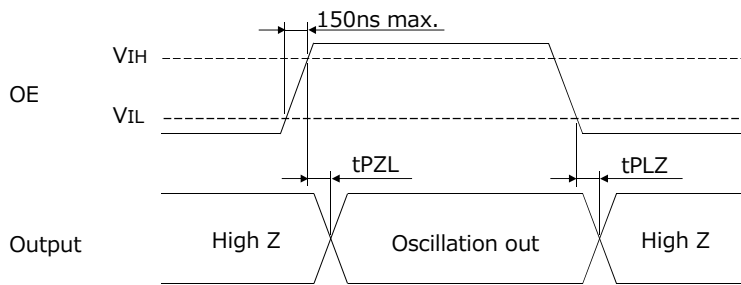
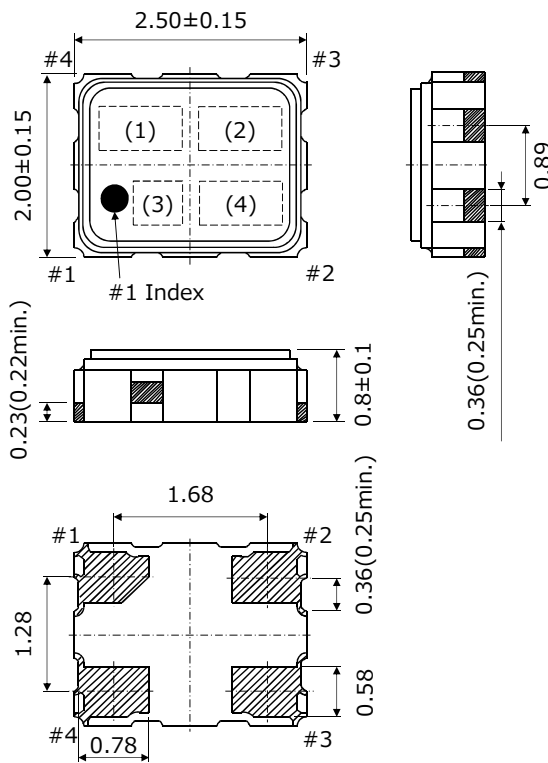

Fig.3 Input output condition

TITLE DSO221SXF TYPE CRYSTAL OSCILLATOR SPECIFICATION		Remark	
Date 2023/06/19	Spec.No. 7FE10000A10	Rev. -	Page 2 / 10

6. Dimensions and Marking

6.1 Dimensions



Pin connections

Pin No.	Connection
#1	OE(Output enable)
#2	GND
#3	Output
#4	Vcc

Unit : mm
 Dimensional tolerance : ±0.1
 (Unless otherwise noted)

6.2 Marking

- (1) Model code SXF
- (2) Frequency ex.) 100.000MHz → 100.
- (3) Logo D
- (4) Lot No. ex.) 2023/01/01 → 301

Year : The last digit of the year

Week : We gave the sequence of week numbers 01(first week) for production date.

There are starting from 1st of Jan. However, add '0' figure to the first week during the nine weeks.

The week means are from Sunday to Saturday.

TITLE DSO221SXF TYPE CRYSTAL OSCILLATOR SPECIFICATION		Remark	
Date 2023/06/19	Spec.No. 7FE10000A10	Rev. -	Page 3 / 10

7. Mechanical characteristics**7.1 Shock****7.1.1 Mounting drop**

A soldered and mounted FR-4 board with thickness of 1.6mm is attached to 100g of aluminum material, and 10cycles of X, Y and Z axis directions (6directions) are dropped on the concrete from height of 150cm. The component shall satisfy requirement of frequency change before and after is within ± 8 ppm.

7.1.2 Acceleration

6ms/1000m/s² to X, Y and Z axes (6directions), 10times.

The component shall satisfy requirement of frequency change before and after is within ± 8 ppm.
No visible damage.

7.2 Vibration

Vibration frequency 10~2000Hz, amplitude 1.5mm (10~55Hz), acceleration 200m/s² (55~2000Hz), 2h in X, Y and Z direction with 20min period.

The component shall satisfy requirement of frequency change before and after is within ± 8 ppm.
No visible damage.

7.3 Sealing tightness

Leak Rate 1.0×10^{-9} Pa·m³/s max. measured by Helium leak detector.

7.4 Solderability

Rosin flux and immerse in soldering bath at +245 \pm 5 $^{\circ}$ C for 3 \pm 0.5s, and 90% or more of the terminal area is new. It must be covered with solder.

7.5 Resistance to soldering heat (Reflow)

When the reflow profile in section 10.1 is measured after 3times, after returning to room temperature (2h intervals) and leaving it for 24 or 48h.

The component shall satisfy requirement of frequency change before and after is within ± 8 ppm.
No visible damage.

8. Environment characteristics**8.1 Humidity**

+60 \pm 2 $^{\circ}$ C, 90~95% R.H., Duration of 240h.

Back to the room temperature first, then in 24h, be checked.

The component shall satisfy requirement of frequency change before and after is within ± 15 ppm.
No visible damage.

8.2 Storage in low temperature

-40 \pm 2 $^{\circ}$ C, Duration of 240h.

Back to the room temperature first, then in 24h, the component shall be checked.

The component shall satisfy requirement of frequency change before and after is within ± 15 ppm.
No visible damage.

8.3 Storage in high temperature

+85 \pm 2 $^{\circ}$ C, Duration of 240h.

Back to the room temperature first, then in 24h, the component shall be checked.

The component shall satisfy requirement of frequency change before and after is within ± 15 ppm.
No visible damage.

8.4 Temperature cycles

-40 $^{\circ}$ C (30min) \leftrightarrow +85 $^{\circ}$ C (30min) shift time 2~3min, 200cycles.

Back to the room temperature first, then in 24h, the component shall be checked.

The component shall satisfy requirement of frequency change before and after is within ± 15 ppm.
No visible damage.

8.5 High temperature operation

+85 \pm 2 $^{\circ}$ C, maximum Vcc, Duration of 240h.

Back to the room temperature first, then in 24h, the component shall be checked.

The component shall satisfy requirement of frequency change before and after is within ± 15 ppm.
No visible damage.

TITLE DSO221SXF TYPE CRYSTAL OSCILLATOR SPECIFICATION		Remark	
Date 2023/06/19	Spec.No. 7FE10000A10	Rev. -	Page 4 / 10

9. Taping and Packing

9.1 Emboss carrier tape specifications

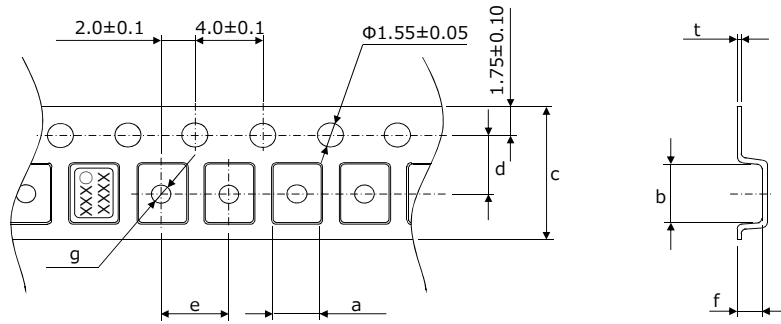

Material : PS (Conductivity)
Unit : mm

Symbol	a	b	c	d	e	f	t	g
Size	2.3 ±0.1	2.8 ±0.1	8.0 ±0.2	3.50 ±0.05	4.0 ±0.1	1.15 ±0.10	0.30 ±0.05	Φ1.05 ±0.05

9.2 Joint of tape

Emboss carrier tape and cover tape should not be jointed.

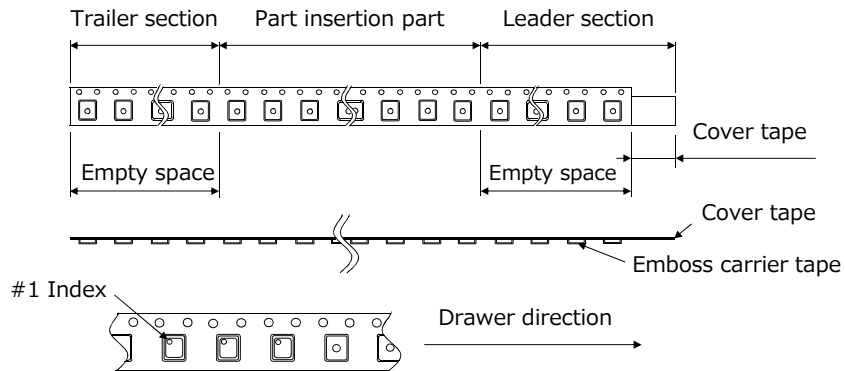

9.3 Taping dimension

Leader section	Cover tape	The length of cover tape in the leader is more than 350mm including empty space area.
	Emboss carrier tape	After all products were packaged, must remain more than 10pieces or 150mm empty space area, which should be sealed by cover tape.
Trailer section	Cover tape	The empty space area which are sealed by cover tape must remain more than 350mm.
	Emboss carrier tape	

TITLE DSO221SXF TYPE CRYSTAL OSCILLATOR SPECIFICATION		Remark	
Date 2023/06/19	Spec.No. 7FE10000A10	Rev. -	Page 5 / 10

- 9.4 Peeling strength of cover tape
 The peeling strength of cover tape pulls and keep to angle 165~180° and make limit 0.1~ 0.7N without prescription, when it pulled it with the speed of 300mm/min.
 (Others conform to JIS C 0806_1990)

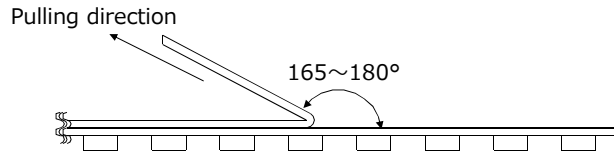

- 9.5 Reel specifications

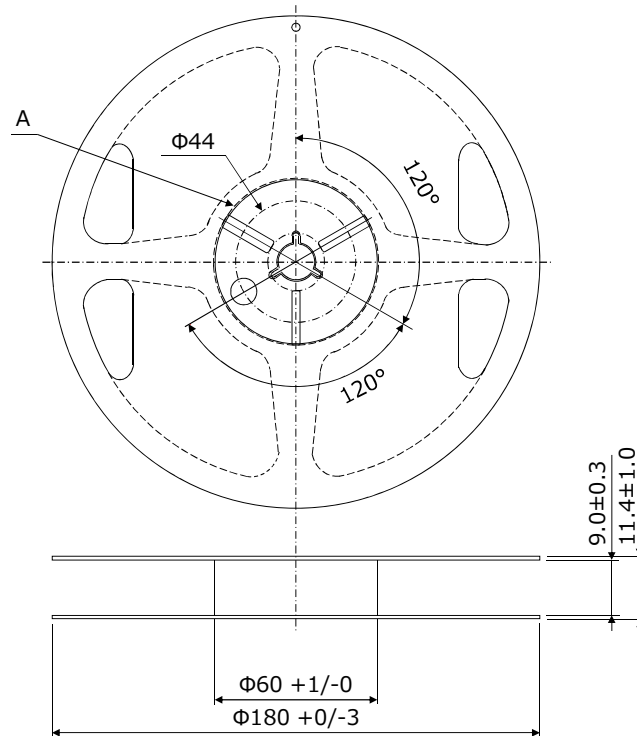

Material : PS (Conductivity)
 Unit :mm

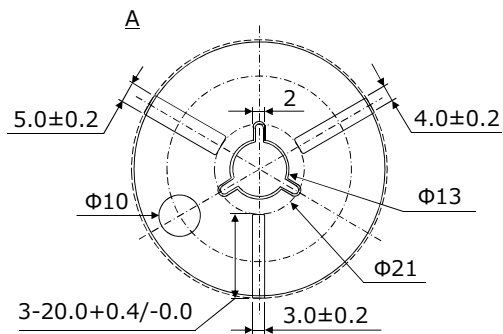

TITLE DSO221SXF TYPE CRYSTAL OSCILLATOR SPECIFICATION		Remark	
Date 2023/06/19	Spec.No. 7FE10000A10	Rev. -	Page 6 / 10

- 9.6 Storage condition
Temperature : +40°C max. Relative humidity : 80% max.
- 9.7 Standard packing quantity
3000pcs. / reel
- 9.8 Label
Label is following information. Printing label at each reel.

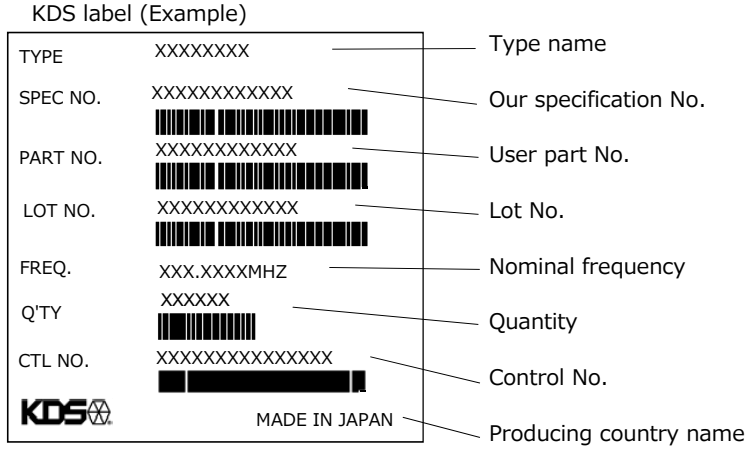

Pb-free label

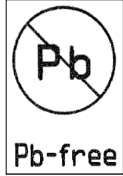

KDS label

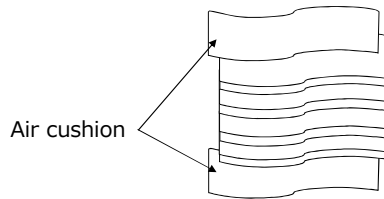
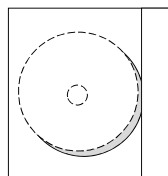
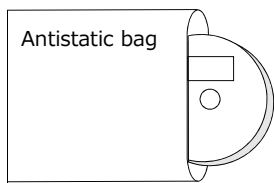
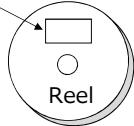

Pb-free label
Indication label

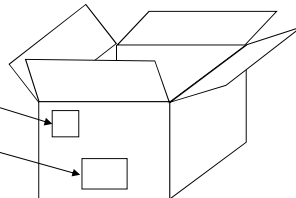

The product is packed up with the method which does not break in the handling by a shipping agent.

TITLE DSO221SXF TYPE CRYSTAL OSCILLATOR SPECIFICATION		Remark	
Date 2023/06/19	Spec.No. 7FE10000A10	Rev. -	Page 7 / 10

10. Supplement

10.1 Reflow condition (Reference)

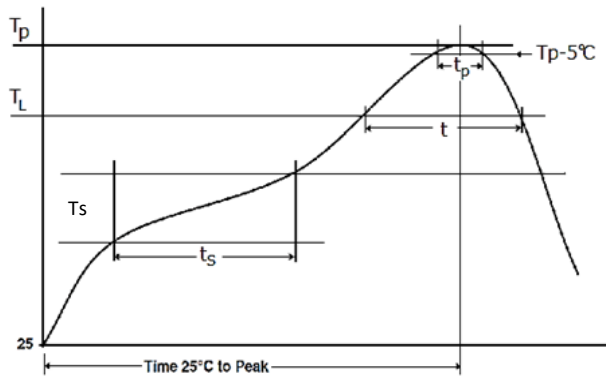

Ts	(°C)	150 ~ 200
ts time	(s)	60 ~ 120
TL	(°C)	217
t time	(s)	60 ~ 150
Tp	(°C)	max. 260
tp	(s)	max. 30

10.2 Reflow count (Reference)

Please stay with our proposed reflow condition and do then soldering 2times max.

10.3 Land pattern layout (Reference)

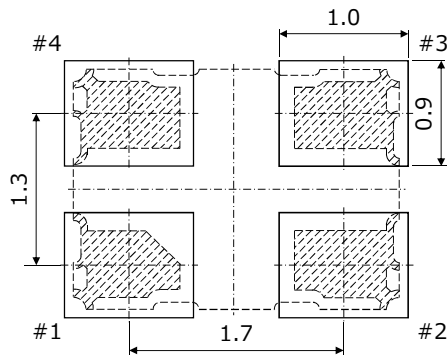

—— Land pattern
Unit : mm

10.4 Mounting

This component is designed for automatic insertion.
However you are requested to do the trial with your insertion machine in order to be sure of proper operation and no damage of component.
Please pay attention to board warp which may damage the component and cause soldering process.
Please mount so that the metalize side and other electrical conductivity structures (a main part lid is included) of the base side do not contact electrically.

TITLE DSO221SXF TYPE CRYSTAL OSCILLATOR SPECIFICATION		Remark	
Date 2023/06/19	Spec.No. 7FE10000A10	Rev. -	Page 8 / 10

- 10.5 Cleaning
Cleaning liquid which corrodes Nickel shall not be used.
It may cause the problem on the surface color marking etc.
Ultrasonic cleaning is possible however you are requested to check on your board.
Because we only checked as single unit.
- 10.6 Handling
This product is designed to withstand Drop and Vibration, however, the crystal blank might be broken.
So if excess force is given, please check the characteristics before use.
This product has C-MOS circuit inside.
Please pay attention to latch-up, static-electricity as same handling as other C-MOS devices.
- 10.7 By-pass capacitor
It has no by-pass capacitor integrated.
We recommend you to use capacitor (like ceramic chip capacitor) 0.01 μ F in-between Vcc and GND.
- 10.8 Storage
Please keep away from high temperature and high humidity, which may cause put solder ability.
No direct Sunlight. No dew as well.
- 10.9 Thrust an ultrasonic cleaning
Because It use a small, thin crystal piece depending on a condition, the inside does resonance,
and there is fear to cause the non-oscillation. When it's the worst, it may be destroyed.
About the ultrasonic cleaning, it is use in the implementation of your company is in a state and
confirming a thing without the influence in the appearance and a characteristic beforehand.
- 10.10 Point out supersonic wave welding
It can't recommend implementation by the supersonic wave welding and the processing so that
the vibration excessive inside of the crystal oscillator propagates, and there is a threat that it cause
characteristic deterioration and the non-oscillation.
- 10.11 RoHS compliance
Following material restricted by RoHS(2011/65/EU,(EU)2015/863) is not included or used.

TITLE DSO221SXF TYPE CRYSTAL OSCILLATOR SPECIFICATION		Remark	
Date 2023/06/19	Spec.No. 7FE10000A10	Rev. -	Page 9 / 10

