

Product Features

1. SMD seam sealed clock crystal oscillator
2. High precision characteristic covering up to high frequency range
3. Designed for automatic mounting and reflow soldering
4. Supply voltage range : 1.62V ~ 3.63V
5. High stability , low phase jitter , low power consumption
6. AEC-Q100 Compliant
7. RoHS and REACH Compliant , Pb-free , Halogen-free
8. Industry Standard Package :
3.2 x 2.5 x 1.0 mm

Application :

- Infotainment & Telematics
- ADAS
- Body Control
- HEV-EV
- Battery Management System
- Smart Cockpit



Test condition

Ambient temperature : 25 ± 5°C

Relative humidity : 40% ~ 70%

● Table 1 . Electrical Specifications

Parameters	Symbol	Min.	Typ.	Max.	Units	Notes
Frequency Range and Stability						
Nominal Frequency	F	0.25 ~ 75			MHz	
Frequency Stability	ST	± 25			ppm	@ -40~85°C , Note 1
		± 30				@ -40~105°C , Note 1
		± 50				@ -40~125°C , Note 1
Operating Temperature Range						
Operating Temperature	Topr	-40	25	125	°C	
Supply Voltage and Current Consumption						
Supply Voltage	Vdd	1.62 ~ 3.63			V	
Current Consumption	Icc	-	-	10	mA	
Standby Current	Icc(ST)	-	-	10	uA	OE = Low
CMOS Type Signal Characteristics						
Output Load : CMOS	CL	15			pF	
Output Voltage High	VoH	90%Vdd	-	-	V	
Output Voltage Low	VoL	-	-	10%Vdd	V	
Rise Time	Tr	-	-	5	ns	10% → 90% Vdd Level
		-	-	4	ns	20% → 80% Vdd Level
Fall Time	Tf	-	-	5	ns	90% → 10% Vdd Level
		-	-	4	ns	80% → 20% Vdd Level
Symmetry (Duty ratio)	TH/T	45	~	55	%	
Start-up Time	Tosc	-	-	3	ms	To 90% of Final Amplitude

Note 1 : Inclusive of frequency tolerance at 25°C , variation over temperature, supply voltage variation, aging and vibration.

Note 2 : The table shows common spec. if you have special spec. requirement , please feel free to contact our salesperson.

Test condition
Ambient temperature : $25 \pm 5^{\circ}\text{C}$
Relative humidity : 40% ~ 70%

● **Table 1 . Electrical Specifications (Continued)**

Parameters	Symbol	Min.	Typ.	Max.	Units	Notes
Enable Pin Control and Input Characteristics						
Enable Control	-	Yes			-	Pad 1
Enable Voltage High	V _{IH}	70%V _{dd}	-	-	V	
Disable Voltage Low	V _{IL}	-	-	30%V _{dd}	V	
Aging Performance						
Aging	-	± 3			ppm/yr.	1st. Year at 25°C
Jitter Performance						
RMS Phase Jitter	PJ	-	-	1	ps	F _{out} range : 10MHz~40MHz @ Integrated from 12KHz ~ 5MHz F _{out} range : 40MHz~100MHz @ Integrated from 12KHz ~ 20MHz

● **Test Diagram**

Pad 1(OE)	Pad 3 (Output)	Oscillator
High (or open)	OSC out	Normal operation
Low	High impedance	Stop oscillation

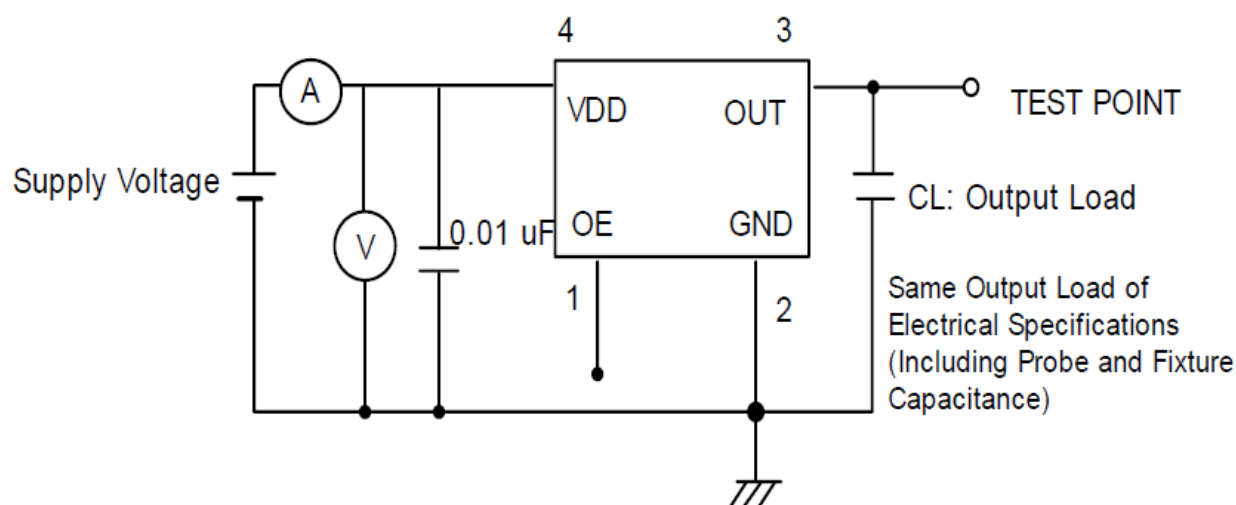

Note : TXC sets CL to 15pF for simulation IC load. Customer does not need to layout it in reality circuit.

● **Waveform Conditions**

Waveform measurement system should have a min. bandwidth of 5 times the frequency being tested.

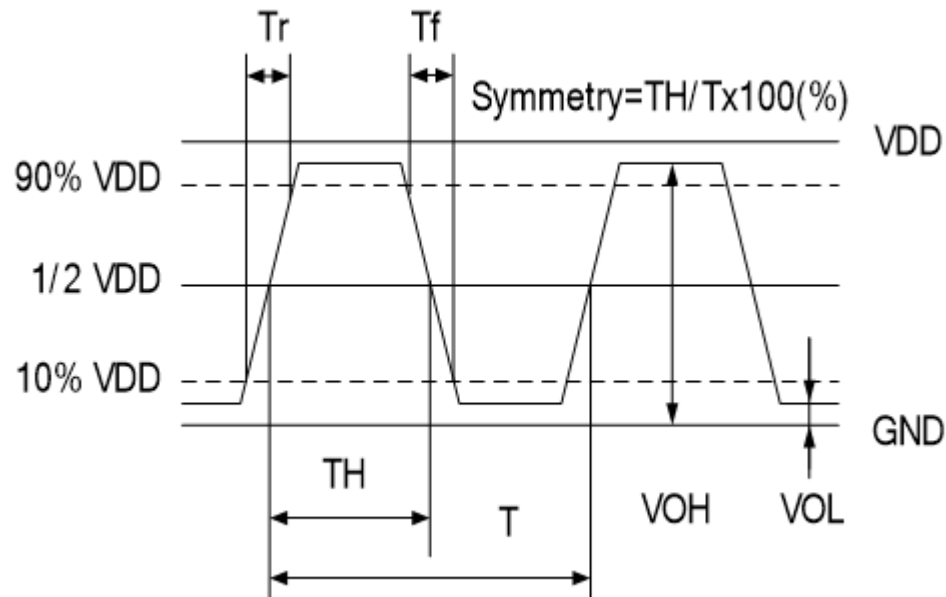

● **Dimensions & Footprint (Recommended)**

Unit : mm

